



**LOGIC
MASTERS**
Deutschland e.V.

www.logic-masters.de

World Puzzle Championship 2019 Kirchheim, Germany

Thursday, 3rd October

09:00 – 09:30	Round 1 Individual: Welcome	30 min	350 points
09:45 – 11:15	Round 2 Individual: Assorted Puzzles	90 min	1100 points
11:30 – 12:15	Round 3 Individual: Permaculture	45 min	450 points
14:00 – 14:45	World Cup Round 1	45 min	600 points
15:00 – 15:30	Round 4 Individual: Roundabout	30 min	250 points
15:45 – 16:45	Round 5 Individual: German Style Puzzles	60 min	700 points
17:15 – 18:00	Round 6 Teams: Patches	45 min	2000 points
18:15 – 19:00	Round 7 Teams: Worms	45 min	1800 points

Friday, 4th October

09:00 – 10:00	Round 8 Individual: Twilight	60 min	600 points
10:15 – 10:45	Round 9 Individual: Miniatures	30 min	250 points
11:00 – 12:15	Round 10 Individual: WPC 28	75 min	850 points
14:00 – 14:45	World Cup Round 2	45 min	600 points
15:00 – 16:00	Round 11 Individual: Irregular	60 min	700 points
16:15 – 17:15	Round 12 Individual: Innovations	60 min	700 points
17:45 – 19:00	Round 13 Teams: Loopfinder	75 min	3000 points

Saturday, 5th October

09:00 – 09:35	Round 14 Individual: Jigsaw Kropki	35 min	300 points
09:50 – 10:35	World Cup Round 3	45 min	600 points
11:15 – 12:45	Team Playoffs		
14:30 – 17:00	World Cup Playoffs		

Competition Rules

Scoring and Bonuses

Points will be awarded only for fully and correctly solved puzzles. In general, there is no partial credit unless stated otherwise in the round's description.

Individual Rounds

A bonus of 10 points for each full remaining minute will be awarded to any competitor who correctly solves all puzzles in a round. A partial 60% bonus can be awarded if one puzzle is incorrectly solved, under the condition that the puzzle is solved completely or almost completely and the competitor may have believed their solution to be correct. In case of doubt, the decision will be made in favour of the competitor; the decision of the judges is final.

Team Rounds

A bonus of 50 points for each full remaining minute will be awarded to any team who correctly solves all the puzzles in a round. If there are any mistakes, then no bonus will be awarded.

Competition Hall Rules

1. All competitors have to sit at their pre-allocated desk in individual rounds. Teams have to work at their pre-allocated desk area for team rounds.
2. Prior to the start of each round, competitors must ensure they are at their desks ready for the start of the round. Late arrivals may not be permitted to enter the competition hall to take part in a round (at the discretion of the organizers).
3. Prior to the start of each round, competitors have to clearly write their name, team and reference number on the front page of their competition booklet into the allocated space. If this information is not complete, then the organizers reserve the right not to award any points to that competitor for that round. Competitors must not open their booklets before the official start of the round.
4. When the signal for the start of the round has been given, competitors may open their booklets and begin solving the puzzles.
5. During each individual round, competitors have to keep silent, unless declaring completion of a round.
6. During team rounds, team members may talk to each other, but should do this with respect to other teams.
7. To declare a round complete, a competitor must close their booklet, clearly state "finished" and raise their arm with the booklet. The competitor's arm must be raised until the booklet is collected. The same rules apply for the team competition.
8. Competitors or teams who complete a round with more than five minutes in advance, are allowed to leave the competition hall quietly.
9. Competitors or teams who complete a round with five minutes or less left are not allowed to leave their desks or tables in order to cause no unnecessary disruption to fellow competitors.
10. When a competitor leaves the competition hall for any reason, they may not be allowed to continue in that round (at the discretion of the organizers).
11. When the signal is given that the round is finished, competitors have to stop solving immediately, close their booklets, put their pens or pencils down and their hands up with their booklets for collecting.
12. At the end of a round, competitors have to remain seated until all booklets have been collected. The signal to get up and leave will be given by the supervisor.
13. Mobile phones and electronic devices are not permitted to use in the competition hall. The devices have to be turned off and must not be placed on the competitor's desk.
14. Only team captains and official observers equipped with a name tag are allowed to enter the competition hall while either individual or team rounds are taking place. Other non-competing participants may enter the competition hall at the discretion of the organizers.
15. Competitors may not use cameras or other recording devices during rounds. Only official observers may do so, at the discretion of the organizers. They have to respect the competitors and not use flash photography or cameras with excessive sounds.
16. When a competitor believes that there is a problem with a puzzle, they must clearly state that puzzle is wrong by writing "Wrong puzzle" next to it. The competitor must not notify the organizers during the round. This will be investigated upon completion of the round.

17. Puzzles can be completed in any order within a round. The points' value of a puzzle is an indication of its expected difficulty, although individual solving experience may differ. The difficulty of an example puzzle does not necessarily reflect the difficulty of the corresponding competition puzzle.

Permitted items

18 Permitted items which can be used in the competition hall (unless stated otherwise) are: pens, pencils, pencil sharpeners, erasers, rulers, blank papers and instruction booklets annotated with notes regarding puzzle instructions and preparation notes.

19. Drinks and snacks are permitted as long as they do not disturb other competitors with a strong smell or rustling packet.

20. It is strictly forbidden to use electronic devices such as music players and headphones or any type of calculator. Use of such equipment may lead to the disqualification of the competitor.

21. Any other items brought into the hall must be kept in a bag on the floor and placed under the competitor's desk, so as not to block the aisles.

Marking and Queries

22. When a round has been evaluated, fully marked booklets are returned to a team member equipped with a country tag at a given location in a given time. Country tags will be distributed to each captain prior the start of the championships.

23. In case of any query after a booklet has been evaluated and returned to a competitor, the query must be raised through a team member with country tag to the organizers in the specified time. The schedule for the queries will be published before the competition. The booklet should be left with the organizers for investigation.

24. Puzzles may be photographed during the marking phase in order to prevent subsequent interventions.

25. Team captains are responsible for ensuring that any information given to them related to the competition is effectively relayed to their team.

Breach of Rules

26. Any breach of these rules may lead to penalty points, or in severe cases to a competitor or team being disqualified from the round or competition.

27. The decision of the WPC tournament director (Ulrich Voigt) is final.

Final Remarks

28. In case of a major mistake in one of the rounds, organizers reserve the right to cancel the round, either by removing it from the time schedule, or by not awarding any points for it to any of the competitors.

29. The official puzzle booklets will contain one or multiple puzzles per page in the individual rounds. The rules of the puzzle and the corresponding points are always written next to it.

30. The official puzzle booklets will not contain puzzle examples. Therefore, we recommend to bring the Instruction Booklet, which contains an example of every puzzle which will be part of the championship.

31. In the team rounds, the official puzzle booklets may contain neither puzzle rules nor examples. It is advised to bring at least one Instruction Booklet for a team for these rounds.

32. In any case of inconsistency between this Instruction Booklet and the official puzzle booklets, e.g. rules or points, the information in the Instruction Booklet will be considered valid.

33. In the competition hall, a timer counting down to the end of the round will be visible for all the competitors.

Puzzle Credits

Authors will remain anonymous individually until the solutions are distributed. The organisers would like to collectively thank Silke Berendes, Rainer Biegler, Jürgen Blume-Nienhaus, Christian Halberstadt, Sebastian Matschke, Erhard Notz, Gabi Penn-Karras, Christoph Seeliger, Roland Voigt, Ulrich Voigt and the World Puzzle Federation for the example and competition puzzles.

World Puzzle Championship and Puzzle World Cup

This year's competition will hold two separate tournaments, namely the World Puzzle Championship and the Puzzle World Cup.

World Puzzle Championship

The World Puzzle Championship is the main competition, very similar to previous WPCs. It consists of 11 individual rounds and 3 team rounds. The individual ranking will be determined by the sum of the scores of all individual rounds; there are no individual playoffs. The competitor with the highest total score will be declared World Puzzle Champion. In case of a tie in the top 3, one single tiebreaker puzzle will determine the final ranking. Details will be announced when the situation arises. In case of a tie outside the top 3, all competitors with the same total score will share the same rank.

The team ranking will be determined by the sum of the individual scores of the four team members, plus the scores of the team rounds. The four teams with the highest total scores will qualify for the team playoffs. In case of a tie, all teams tied for fourth place will qualify for the team playoffs.

Team Playoffs

Teams will start the playoff with time offsets based on the preliminary results, according to the following formula:

Time offset = (Score difference / 10) seconds

However, if this formula would lead to a time offset of more than 7 minutes, the time offset for the team in 4th place will be set at 7 minutes and the time offsets for the other teams will be calculated proportionally according to their score differences.

The team playoffs will consist of an individual part and a team part. In the individual part, there are four sets of two puzzles. Each team member must solve one of these sets individually. The distribution of these sets to the team members is part of the team strategy. Within each set, there is no defined order of the puzzles.

When a competitor solves the first puzzle of their set, they hand the solved puzzle to a judge and continue with the second puzzle. If the solution is correct, they will be briefly notified. If the solution is incorrect, the judge will return the incorrect puzzle to the competitor who can decide for themselves which puzzle to continue first.

When a competitor solves the second puzzle of their set, they hand their solved puzzle to a judge to enter the submission period. The entire solution will then be checked over the next minute. If the solution is incorrect, the judge will return the incorrect puzzle to the competitor. The competitor can resubmit a returned puzzle at any time, and will again enter the submission period. If the solution is correct and thus both puzzles are solved correctly, the competitor advances to the team table.

A competitor solving the individual puzzles may, at any time, ask for assistance from team mates who have already advanced to the team table. Any competitor who already advanced to the team table may decide to help one of their team members and join them at their individual table. However, when they decide to do so, they must remain at this individual table until both puzzles are solved correctly. Multiple team members may give assistance, but with the same restriction. Team members may communicate with each other to decide their team strategy.

The team part consists of four puzzles. Competitors who advance to the team table can start solving, however the puzzles cannot be solved completely unless all four team members have arrived at the team table. Teams can solve these puzzles in any order they like, however they can only work on one puzzle at a time. When a team finishes a puzzle, they notify the judges to enter the submission period. The entire solution will then be checked over the next minute. After one minute, if the solution is correct, the team continues with the next puzzle. If the solution is incorrect, the judges return the puzzle to the team. Teams can resubmit a returned puzzle at any time, and will again enter the submission period.

The team who finishes all four team puzzles first is declared winner. The team playoffs end when three teams finish. If this has not happened after 90 minutes, the playoffs will be aborted; the final ranking is determined by (a) number of correctly solved puzzles, (b) time of the last correct submission, (c) total team score of the preliminary rounds.

Puzzle World Cup

The Puzzle World Cup is a new knockout tournament, completely independent from the World Puzzle Championship, and replaces the individual playoffs from previous years. It starts with three regular puzzle rounds. In the first round, anyone can compete. After the first round, the top 100 competitors advance to round 2. The second and third round are similar, with 40 respective 16 competitors advancing. For the ranking in each round only the scores of the current round are considered, results of earlier rounds are not counted.

For competitors who solve all puzzles with time to spare, the same bonus rules as in the World Puzzle Championship apply.

In case of a tie after round 1 or round 2, anyone tied for 100th or 40th place will advance to the next round. For round 3 the situation is different: If there is a tie for 16th place, the competitors who scored better in round 2 will

advance, and if that fails to distinguish, the competitors who scored better in round 1 will advance. If there is still a tie after that, a single tiebreaker puzzle will decide who advances; details will be announced when the situation arises.

Note: Competitors who have been eliminated in an earlier round may still join the later rounds and solve the puzzles; their booklets will not be graded though. All three World Cup rounds are not counted towards the World Puzzle Championship.

Individual Playoffs

The 16 competitors who advanced from round 3 will determine the winner via individual playoffs. The competitors will be drawn into four semifinals of four players, the winner of each semifinal advances to the final. There will be no carry-over, in each semifinal all four players start at the same time.

For these playoffs, a puzzle pool with 35 puzzles will be used. Before each semifinal five puzzles are drawn. These puzzles have to be solved in order; the first competitor to solve all puzzles correctly advances to the final. No puzzle will be used for more than one playoff round. A list of puzzle types will be provided during the WPC.

When a play-off competitor completes a puzzle, they hand their solved puzzle to a judge to enter the submission period. The entire solution will then be checked over the next minute. After one minute, if the solution is correct, the judge will allow the competitor to begin the next puzzle. If the solution is incorrect, the judge will return the incorrect puzzle to the competitor. The competitor can resubmit a returned puzzle at any time, and will again enter the submission period.

When one competitor has solved all puzzles correctly, they advance to the final, and the semifinal ends. If this has not happened after 35 minutes, the semifinal is aborted. In this case, the winner of the semifinal is determined by (a) number of correctly solved puzzles, (b) time of the last correct submission, (c) total score of the three preliminary World Cup rounds. If the abort happens while a competitor is in their submission period and the submitted solution is correct, the solved puzzle is counted for the ranking.

The final will be conducted in the same way as the semifinals. Again, five puzzles are drawn, and the first competitor to solve all puzzles correctly is declared the winner of the Puzzle World Cup. The only difference is that the final does not end after the winner is determined, but after either three competitors have finished or 35 minutes have elapsed. If the final is aborted after 35 minutes, the final ranking is determined by (a) number of correctly solved puzzles, (b) time of the last correct submission, (c) total score of the three preliminary World Cup rounds.

Notation

The participants are allowed to use different notations, as long as it is clear how the chosen notation translates into the given task.

Examples:

- In dissection puzzles, it is allowed to draw the connecting lines between all cells belonging to the same region. Isolated cells which do not have any connecting lines are considered regions of size 1. Note, however, that if there are adjacent cells without any connecting lines remaining, the dissection and thus the solution will be considered as incomplete. If the solution is intended to have adjacent one-cell regions, they must at least be marked as such by small dots/circles or similar, denoting the absence of connections.
- In shading puzzles it is allowed to instead mark the respective cells with symbols, such as X's. If, for example, the shaded cells form an area (as in Tapa or Nurikabe), it is also allowed to draw the connecting lines spanning the entire shaded area.
- Conversely, in path/loop puzzles through grid cells it is allowed to shade or otherwise mark the cells spanning the loop – but only as long as the pathway remains unique! This means, in puzzles where the path/loop is allowed to touch itself in a manner consistent with pathways, marking the cells is not considered sufficient, even if it turns out there would be only one pathway satisfying the global puzzle rules.

If the task is to fill all grid cells (e.g. with symbols as in Latin Squares, but also with symbols and shading as in Japanese Sums, Magnets and the like), cells cannot remain empty. Empty cells will not automatically be considered as shaded; the solution will be considered incomplete.

Whatever notation is used, it has to be used consistently throughout the solution! In a dissection puzzle, for example, a solution which uses connecting lines in half the grid and boundaries in another half is typically not considered valid; if two different complete notations are used throughout the grid, the solution will typically only be considered correct only if both notations display the same solution.

All this is at the judge's discretion.

Puzzle Glossary

The terminology in the puzzle instructions is generally used in the following sense, unless the rules of a particular puzzle specifically say otherwise.

Adjacent Cells: Two cells are said to be adjacent if they share an edge. For example, in a square cell grid, two cells are adjacent if and only if they lie horizontally or vertically next to each other.

Touching / Neighbouring Cells: Two cells are said to be touching or neighbouring if they share at least a point. Adjacent cells are automatically touching.

Connected: A group of cells is said to be (inter)connected if for every pair of cells it is possible to find a path connecting the two cells which lies completely within the group, and which only travels from one cell to an adjacent cell in each step.

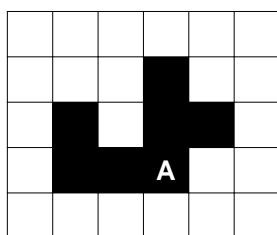

This group of shaded cells is connected. If the cell marked “A” is removed, the group is no longer connected.

Region: A region is a set of connected grid cells, which is typically marked by drawing the borders of the region bold (or sometimes by shading all the cells in the region). Regions may have holes, unless otherwise noted.

In some puzzle styles the task is to divide the given grid into regions, in others the dissection is already given. Also, sometimes the task is to place certain regions in the grid, but without using all the grid cells.

Shape: A shape is essentially a region for a dissection or placement puzzle; the term “shape” is typically used instead of “region” when the set of shapes that must be used is already given, as in Tetromino/Pentomino puzzle styles. Note that, in such puzzles, the rules state whether rotating or reflecting the given shapes is allowed.

Area / Size: The area or size of a region/shape is the number of cells that belong to it. Potential holes are not counted here.

Congruent: Two regions are said to be congruent if it is possible to find a sequence of movements (shifting, rotating and possibly reflecting) that transforms one of the regions exactly into the other. As a consequence, two congruent regions must always consist of the same number of cells. For example, there are exactly 5 different tetromino shapes and 12 pentomino shapes.

Pentomino: A pentomino is a shape consisting of five connected cells in a square grid. There are twelve different pentominoes:

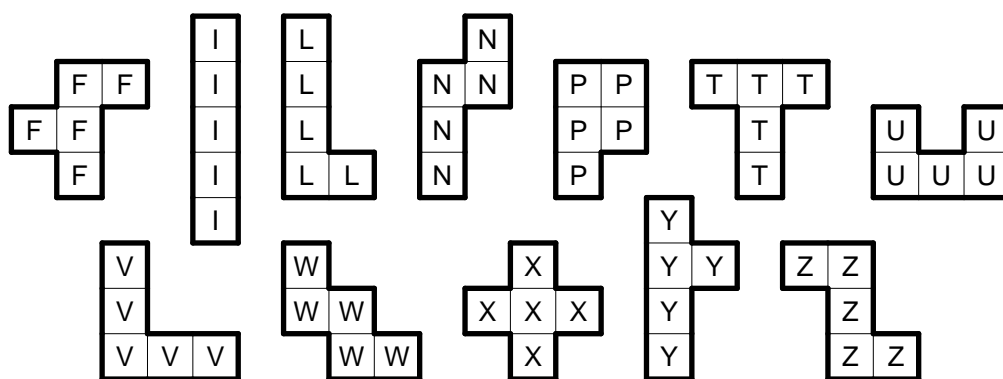

Pentominoes are labelled with the letters shown here. In some puzzles these letters have actual meaning, usually when some letters are marked in the puzzle grid and the respective pentominoes must be placed there.

Similarly, there are five tetrominoes (seven, if reflected shapes are considered different) and 35 hexominoes, consisting of four respectively six connected cells in a square grid.

Object Placement: There are various puzzles where the task is to place certain objects in the grid (often the size of one cell, like stars, sometimes larger ones). The rules regarding the location of these objects – in particular the possibility of touching – always refers to the underlying cells containing these objects in the solution, even if the graphics appear to leave a space between the objects and the cell boundaries.

Dissection: There are various puzzles where the task is to divide the grid into regions. Unless otherwise noted, the dissection must take place along the grid lines, and every cell must belong to exactly one region (i.e. there cannot be either overlaps or leftovers).

Drawing Lines: There are various puzzles where the task is to draw lines in the grid (loops, connections, etc). In some puzzles styles like Slitherlink, these lines must run along grid lines; in other puzzle styles like Masyu, they run through grid cells.

In puzzles where lines through grid cells are to be drawn, it is customary to always draw them through the center points of the respective cells. This means, for example, that a loop passing through a cell more than once will always hit itself (even though it would theoretically be possible to draw the lines such that they pass through different parts of a cell without touching itself). If there is a rule that no cell can be used more than once, this will then automatically imply that the lines cannot hit each other (or that the loop cannot hit itself).

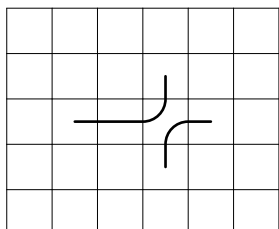

These two path segments use the same cell, which is usually not allowed.

Loop: A loop is a closed and connected set of line segments, i.e. there are no open ends, and there cannot be two or more separate loop components. Note that the connection requirement is stronger than that of the underlying cells being connected.

Snake: A snake is a single path in the grid which travels through adjacent cells only. Snakes often use a special notation, such as shaded cells or circles with number sequences instead of line segments, although this is not always relevant for the respective puzzle style.

Snakes are not allowed to “touch” themselves. This means, if two adjacent cells are used by the snake, the underlying snake path must directly connect the one cell with the other; if two (diagonally) touching cells are used by the snake, the underlying path must connect the two cells via adjacent cells without a detour. The same non-touching condition is also sometimes used for loops (e.g. Bosnian Road).

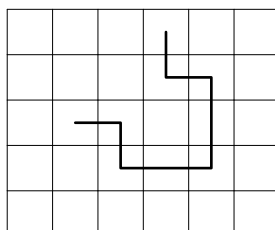
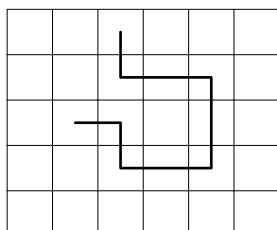

Both paths touch themselves.

Length: The word “length” (for example of paths or contiguous cell groups) is not used with the same uniform meaning throughout the instruction booklet. Sometimes – typically in shading puzzles, as in Coral – the term refers to the number of cells; sometimes – typically in loop/path puzzles, as in Castle Wall – it refers to the number of steps from one end to the other, i.e. the number of cells minus one. Read the specific puzzle instructions (and check the example) to find out which one is the case.

Knapp Daneben: “Knapp Daneben” is the name of a variant that applies to many puzzle types involving numbers. It means that all given clues are off by exactly 1, i.e. the correct clue would be 1 higher or 1 lower than the number given in its place.

Coded: “Coded” is the name of a variant that applies to many puzzle types involving numbers. It means that the numbers have been replaced by symbols (typically letters); the substitution is such that same symbols correspond to same numbers, different symbols correspond to different numbers.

Note, however, that sometimes the substitution refers to single digits only, and sometimes it refers to multi-digit numbers – read the specific puzzle instructions to find out which one is the case.

Incomplete Information: In many puzzles the potential position of clues is fixed, for example outside the grid or in certain marked cells. If such a position does not contain a clue, this means that the respective information is not given (rather than take the value 0).

Puzzle sizes: The instructions (for example “Enter numbers from 1 to 6 ...”) always refer to the size of the competition puzzles. The examples often use smaller grids, smaller sets of shapes etc. Usually this should be obvious; in some cases when this may not be the case we have explicitly mentioned a different size.

Round 1 Individual: Welcome

30 minutes – 350 points

- 1.1 Easy as Word Snake 35 points
- 1.2 ABCtje 50 points
- 1.3 Alphabetic 30 points
- 1.4 Crossword 55 points
- 1.5 Coded Fillomino 25 points
- 1.6 Masterword 40 points
- 1.7 Word Search 20 points
- 1.8 Tangled Words 1 30 points
- 1.9 Tangled Words 2 65 points

1.1 Easy as Word Snake

35 points

Place a snake into the grid that doesn't touch itself, not even diagonally. The cells of the snake contain the sequence of letters and digits shown below (one character per cell, no spaces). Head and tail of the snake are given.

The numbers outside the grid (above and to the left) indicate how many snake cells appear in the respective row or column. The letters outside the grid (below and to the right) indicate the character in the first snake cell in the respective row or column, seen from the respective direction.

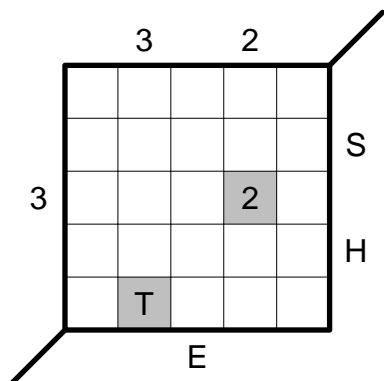

THE ANSWER IS 42

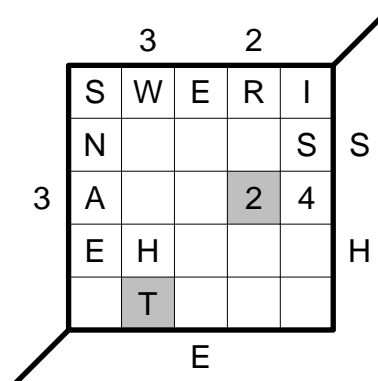

1.2 ABCtje

50 points

Assign numbers from 1 to 15 to the letters that appear in the given words. Different letters correspond to different numbers. For each word, the sum of the numbers corresponding to its letters is given.

- AMUN = 22
- ANUBIS = 25
- HORUS = 35
- ISIS = 8
- OSIRIS = 24
- RA = 18

- AMUN = 22
- ANUBIS = 25
- HORUS = 35
- ISIS = 8
- OSIRIS = 24
- RA = 18

A	B	H	I	M	N	O	R	S	U

A	B	H	I	M	N	O	R	S	U
8	4	9	1	5	2	6	10	3	7

1.6 Masterword

40 points

Find the six letter master word with the help of several clue words.

Each clue word is compared to the master word. A black circle indicates a letter that appears in both words in the same position. A white circle indicates a letter that appears in both words in different positions. Letters may repeat in the master word and in the clue words; a letter yields multiple circles only if it appears multiple times in both.

A	R	I	E	L	○	○		
B	E	A	S	T	●	○		
B	E	L	L	E	●			
S	I	M	B	A	●	●	○	○
T	I	A	N	A	○	○		

A	R	I	E	L	○	○		
B	E	A	S	T	●	○		
B	E	L	L	E	●			
S	I	M	B	A	●	●	○	○
T	I	A	N	A	○	○		

--	--	--	--	--	--

● ● ● ● ●

B	A	M	B	I
---	---	---	---	---

● ● ● ● ●

1.7 Word Search

20 points

Enter letters into the empty cells, so that each word from the given list can be read in the grid horizontally, vertically or diagonally, forwards or backwards (eight possible directions).

Note: It is sufficient to enter the missing letters, it is not necessary to mark the location of the words.

A	Z	E	U	S	M	A
P	N	H	C	I	L	N
O	H				E	S
L	A				R	A
L	D				O	R
O	E	O	N	R	A	E
R	S	S	I	A	B	S

APOLLO
 ARES
 ARTEMIS
 ATHENA
 EROS
 HADES
 HELIOS
 HERA
 HERMES
 ZEUS

A	Z	E	U	S	M	A
P	N	H	C	I	L	N
O	H	E	R	M	E	S
L	A	L	H	E	R	A
L	D	I	R	T	O	R
O	E	O	N	R	A	E
R	S	S	I	A	B	S

1.8 Tangled Words 1

30 points

Place the given words into the grid, according to the following rules:

Each word starts in a grey cell. The next letter must be placed in the horizontally or vertically adjacent cell indicated by the direction of the arrow. Any further letter must be placed horizontally or vertically adjacent to the preceding letter. Words may use the same cell more than once; however, if a word contains a double letter (the same letter twice in a row), it still has to use two different cells for these. Multiple words can start in the same grey cell if and only if there are multiple arrows emanating from that cell. A letter in a grey cell must be the starting letter for at least one word.

Cells with circles contain vowels (A, E, I, O, U), and vowels must be placed in cells with circles.

Cells may remain empty. Each letter must be used by at least one word.

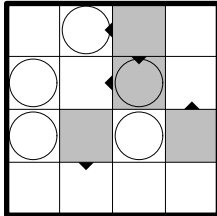

ONE
TWO
THREE
FOUR
FIVE

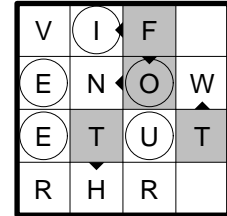

Note: Tangled Words 1 and Tangled Words 2 have different rules.

1.9 Tangled Words 2

65 points

Place the given words into the grid, according to the following rules:

Each word starts in a grey cell. Any further letter must touch the preceding letter horizontally, vertically or diagonally. Words may use the same cell more than once; however, if a word contains a double letter (the same letter twice in a row), it still has to use two different cells for these. Multiple words can start in the same grey cell. A letter in a grey cell must be the starting letter for at least one word.

Some letters are already given. For every such letter, all copies are given, and no further copies of that letter may be entered in the grid.

Cells may remain empty. Each letter must be used by at least one word.

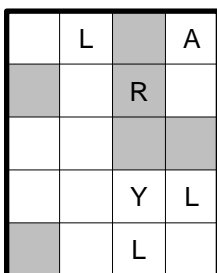

BILL
CHARLIE
FRED
GEORGE
GINNY
PERCY
RON

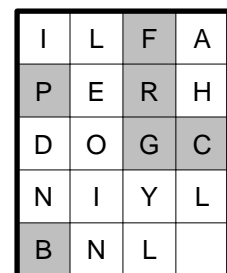

Round 2 Individual: Assorted Puzzles

90 minutes – 1100 points

2.1 Touching Tetrominoes	10 points
2.2 Walls	15 points
2.3 Skyscrapers	15 points
2.4 Neighbours	20 points
2.5 Kurotto	25 points
2.6 Corridors	25 points
2.7 Skyscrapers – Mixed Information	30 points
2.8 Permit A38	30 points
2.9 Hakyuu	30 points
2.10 LITS+	40 points
2.11 Killer Pyramid	40 points
2.12 Top Heavy Number Place	45 points
2.13 Coral Snake	45 points
2.14 Galaxies	50 points
2.15 Achtelwenden	55 points
2.16 Terra X	60 points
2.17 Outside Yin & Yang	65 points
2.18 Japanese Sums and Products	65 points
2.19 Serrated Doppelblock	70 points
2.20 Anti Magnets	75 points
2.21 Toroidal Snake	80 points
2.22 Magic Pathways	90 points
2.23 Elbschiffer Loop	120 points

2.1 Touching Tetrominoes

10 points

Place the full set of tetrominoes into the grid, each tetromino exactly once, so that no two tetrominoes share a border. Tetrominoes can be rotated but not reflected. All grid points where two tetrominoes touch diagonally are marked with a black dot.

In the puzzle booklet, the full set of tetrominoes will be shown.

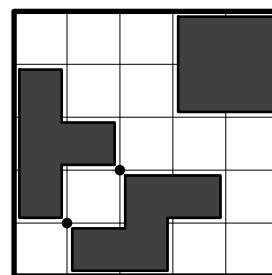
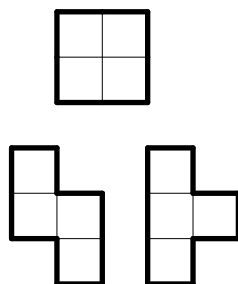
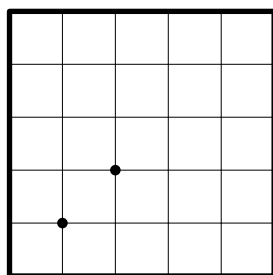

2.2 Walls

15 points

Draw a horizontal or vertical line segment into each empty cell. The numbers indicate the total length of all horizontal or vertical lines connected to the respective cells.

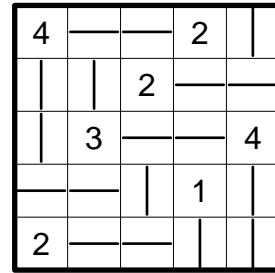
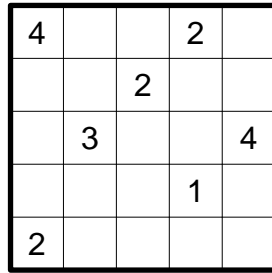

2.3 Skyscrapers

15 points

Enter numbers from 1 to 6 into the grid, so that each number appears exactly once in each row and column. These numbers represent skyscrapers of the corresponding height. The numbers outside the grid indicate how many skyscrapers can be seen in the respective row or column from the respective direction. Smaller skyscrapers are hidden behind higher ones.

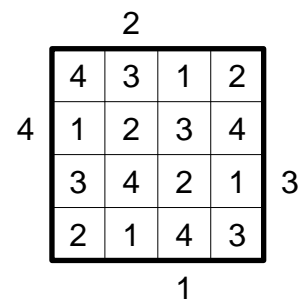
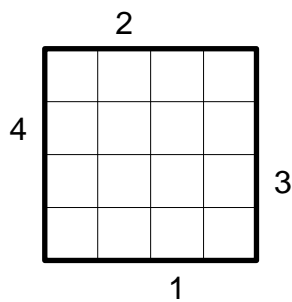

2.4 Neighbours

20 points

Enter numbers 1, 2, 3 into the grid, so that each number appears exactly twice in each row and column. Numbers in grey cells cannot share an edge with a cell containing the same number. Numbers in white cells share an edge with at least one cell containing the same number.

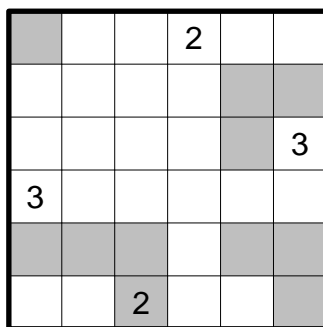

2.5 Kurotto

25 points

Shade some cells to form groups of connected shaded cells. These groups can touch each other diagonally. Cells with circles cannot be shaded. The numbers indicate the sum of the sizes of all such groups where at least one shaded cell is horizontally or vertically adjacent to the numbered cell. For cells without numbers, these sums are unknown.

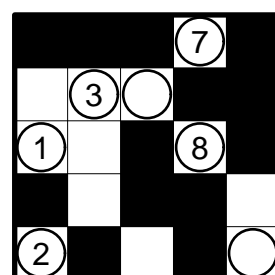
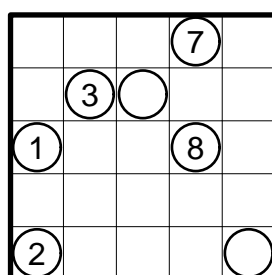

2.9 Hakyuu

30 points

Enter numbers into the grid, so that each region of size N contains numbers from 1 to N , each number exactly once. If the same number appears multiple times within a row or column, the number itself indicates the minimum distance between these numbers: each pair of equal numbers N in the same row or column must be separated by at least N other cells between them.

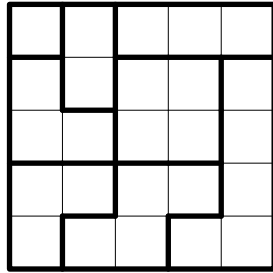

1	2	3	1	2
2	1	4	3	1
1	3	1	2	4
3	1	2	1	3
2	4	3	5	2

2.10 LITS+

40 points

Shade some cells, so that each region contains either no shaded cell at all or exactly four connected cells that form a tetromino. No 2×2 square can be completely shaded or completely unshaded. All tetrominos must be connected. Tetrominoes with the same shape, regardless of rotation or reflection, cannot share an edge.

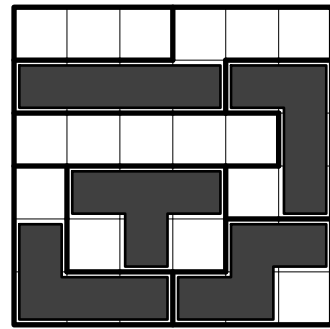
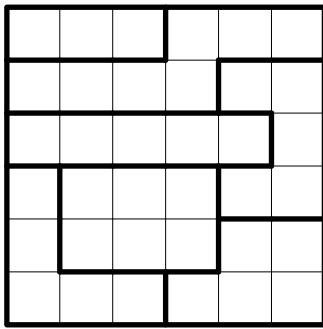

2.11 Killer Pyramid

40 points

Enter a number from 1 to 9 into each empty cell, so that (with the exception of the bottom row) each number is either the sum or the difference of the two numbers directly below it. Within a shaded row, no number can appear more than once. In an unshaded row there must be at least one number appearing more than once. Within each small cage, the numbers must add up to the sum given in the top left cell, and no number can appear more than once.

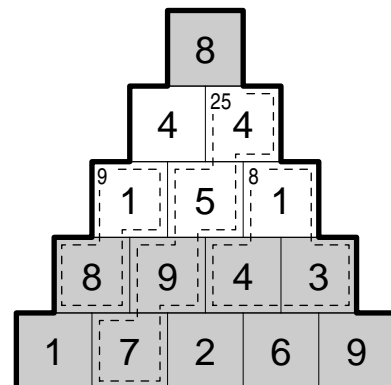
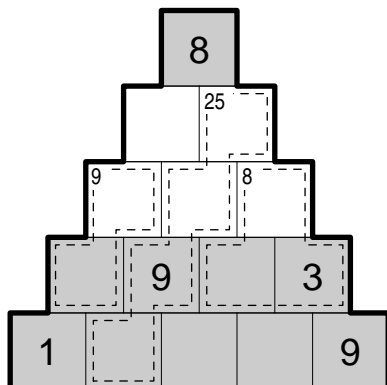

2.12 Top Heavy Number Place

45 points

Enter numbers from 1 to 5 into the grid, so that each number appears exactly once in each row and column. Whenever two vertically adjacent cells both contain numbers, the greater number must be placed above the smaller number.

			2		4
		2			
				3	
3				1	
2	4				1

	1	3	2		4
		2	1	4	3
4	2	1		3	
3			4	1	2
2	4		3		1
1	3	4		2	

2.13 Coral Snake

45 points

Shade some cells to create a coral: all shaded cells are connected, all unshaded cells are connected to the border of the grid and no 2x2 square is completely shaded.

Further, draw a snake into the grid that doesn't touch itself, not even diagonally. The cells marked with circles contain head and tail of the snake. Snake and coral cannot overlap, and coral cells and snake cells cannot share an edge, but they can touch diagonally.

The clues outside the grid describe the contents of the respective row or column. For each row or column, one of the numbers indicates the number of snake cells in the respective row or column; each other number corresponds to a contiguous group of coral cells, the number indicates the length of that group. However, if a row or column contains no coral cells or no snake cells at all, the clue number 0 will be omitted. For some rows or columns the clues have been omitted entirely.

	1			1	1
	2			2	2
3					
1	4				
1	3				
2	3				

	1			1	1
	2			2	2
3					
1	4				
1	3				
2	3				

2.14 Galaxies

50 points

Divide the grid along the grid lines into regions, so that each region contains exactly one grey dot. Each region must have rotational symmetry, and the grey dot must be located in the center of rotation.

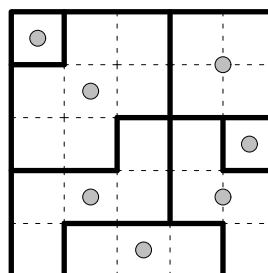
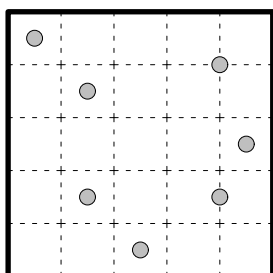

2.15 Achtelwenden

55 points

Draw a closed loop into the grid, that travels horizontally, vertically and diagonally and passes through each cell exactly once. The loop may cross itself. The numbers indicate what kind of turn the loop makes in the respective cells: a clue number times 45° gives the angle formed by the loop, see figures below (rotations are possible).



2		4		1
1	1	2		
1	4		4	
1	3	4		2

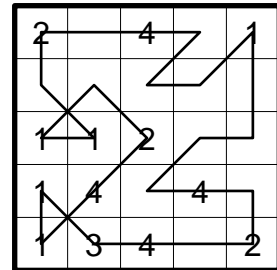

2.16 Terra X

60 points

Enter numbers from 0 to 9 into the grid, one into each region. Regions with equal numbers cannot share an edge (they may touch diagonally). For each grid point where four regions meet, the sum of the numbers in those regions must equal 10. For your convenience, all these grid points are marked with a small black dot.

6				4
			3	
	7	2		
		0		4
1			5	

6	3		1	4
	1	0	3	2
0	7	2		3
3		0	1	4
1			5	0

2.17 Outside Yin & Yang

65 points

Divide the grid along the grid lines into two parts, so that within each part all cells must be connected, and each cell must belong to exactly one part. No 2×2 square is located completely within one part. The numbers outside the grid indicate the longest contiguous block of cells in the respective row or column that all belong to the same part.

	3		1	
3				
2				

	3		1	
3	●	●	●	○
2	○	●	○	○
	○	●	●	○
	○	○	○	○

2.18 Japanese Sums and Products

65 points

Enter numbers from 1 to 6 into the grid, so that each number appears at most once in each row and column, and shade the remaining cells. The numbers outside the grid describe the contents of the respective row or column. Each number corresponds to a contiguous group of numbers (possibly a single number) and indicates either the sum or the product (or possibly both) of these numbers. Two such groups are separated by one or more shaded cells. For each row and column the numbers outside are shown in correct order.

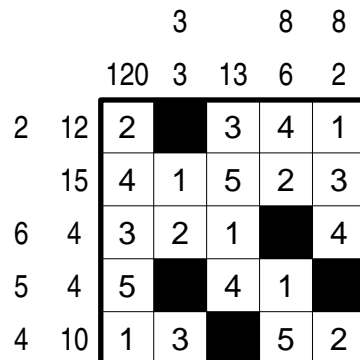
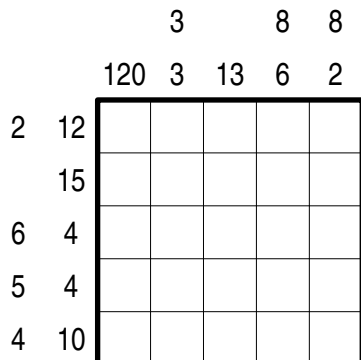

2.19 Serrated Doppelblock

70 points

Enter numbers from 1 to 7 into the grid and shade the remaining cells, so that each full row and column (consisting of nine cells) contains each number exactly once as well as two shaded cells. The clue numbers next to these rows or columns indicate the sum of the numbers between the two shaded cells in the respective row or column; a sum of 0 means that the shaded cells are adjacent. Incomplete rows (less than nine cells) can contain any number of shaded cells; numbers cannot repeat in such a row or column. The clue numbers next to these rows or columns, marked with arrows, indicate the sum of all numbers in the respective row or column.

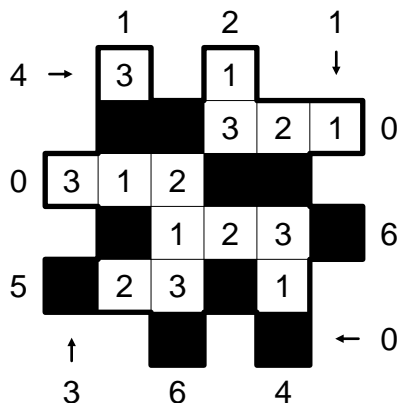
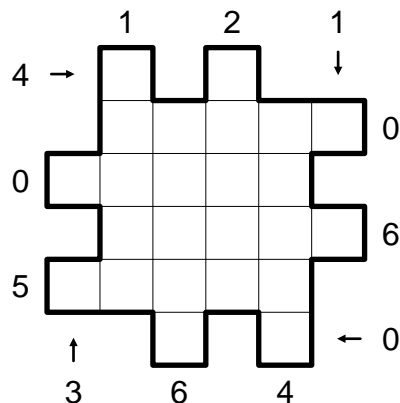

2.20 Anti Magnets

75 points

Fill the grid with neutral (shaded) and magnetic plates. Each magnetic plate has two poles, represented by + and - signs. Poles of different types that are part of different plates cannot be horizontally or vertically adjacent. The numbers indicate how many poles of the corresponding type appear in the respective row or column.

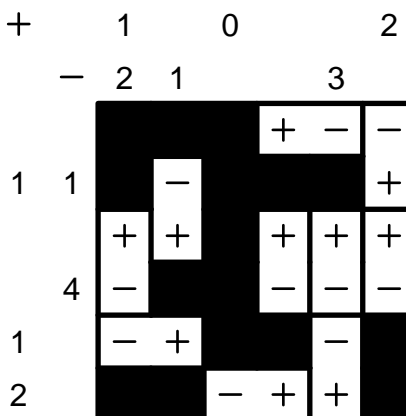
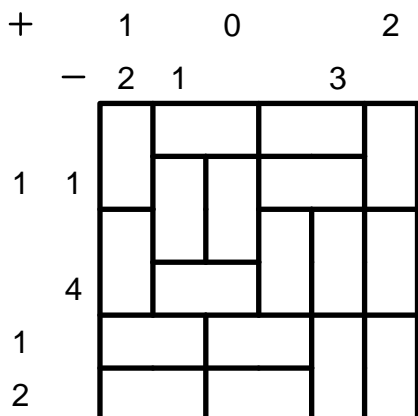

2.21 Toroidal Snake

80 points

Draw a snake into the grid that doesn't touch itself, not even diagonally. The numbers indicate how many snake cells appear in the respective row or column. Head and tail of the snake are not given.

The grid is toroidal, which means that the topmost row and bottom row are considered adjacent, likewise the leftmost column and the rightmost column. This applies both to the path of the snake and to the non-touching condition.

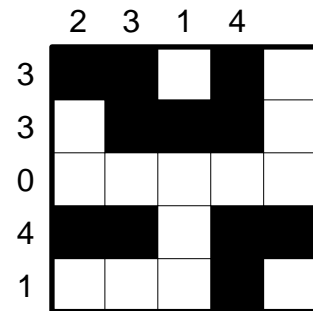
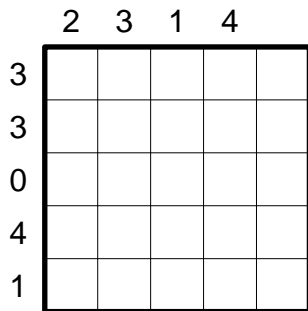

2.22 Magic Pathways

90 points

Enter numbers from 1 to 4 into the grid, so that each number appears exactly once in each row, column and outlined region. Cells marked with a – cannot contain any numbers. Within each region, it must be possible to find a path that runs horizontally and vertically through each cell exactly once, including those marked as empty, and along the path the numbers from 1 to 4 appear in order. Such a path cannot cross bold lines. If a region has an entrance from the outside, the path must start at that entrance, and starting from that entrance the number 1 must appear first on the path.

Note: It is sufficient to enter the numbers, it is not necessary to mark the paths.

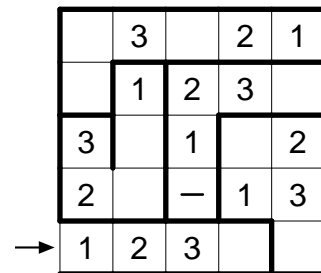
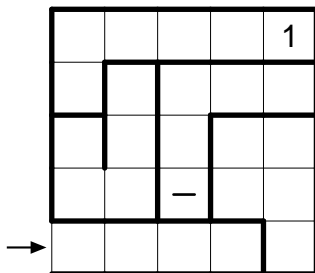

2.23 Elbschiffer Loop

120 points

Draw a closed loop along the dotted lines that uses each grid point at most once. The loop must pass through all marked grid points. Traveling along the loop, in each grid point marked + the loop must turn left and in each grid point marked × the loop must turn right.

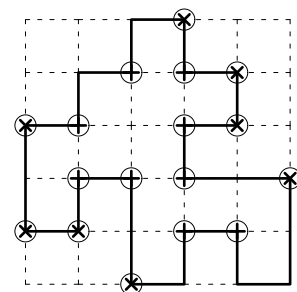
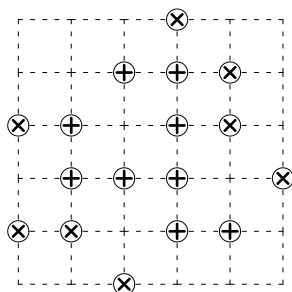

Round 3 Individual: Permaculture

45 minutes – 450 points

3.1 Arukone + Pentominoes	30 points
3.2 Nurikabe + Railroads	35 points
3.3 Hakyuu + Star Battle	40 points
3.4 Aquarium + LITS	50 points
3.5 Dominoes + Slitherlink	60 points
3.6 Creek + Slant	65 points
3.7 Anglers + Battleships	80 points
3.8 Masyu + Yin & Yang	90 points

All puzzles in this round are Permaculture hybrids. Each grid consists of two separate parts containing different puzzle types.

The general task for each puzzle is: Divide the grid into two parts, so that each part contains one of the given puzzle types. Within each part all cells must be connected, and each cell must belong to exactly one part. It is possible that one part completely surrounds the other. Aside from this division, the parts are completely independent and do not interact with each other.

Please note especially which puzzle types allow empty cells in their parts and which do not.

For a correct solution, both parts must be solved and the border between both parts must be clearly visible. If both parts use a similar notation (for example in 3.4, Aquarium + LITS), then the border must be explicitly drawn. If clearly different notations are used, the border can be omitted.

There are no partial points, for example if only one part of a puzzle is solved.

3.1 Arukone + Pentominoes

30 points

Arukone: Connect each pair of identical letters by a line that runs horizontally and vertically. Each cell is used by exactly one such line.

Pentominoes: Divide the grid into pentominoes, so that each cell is part of exactly one pentomino and each pentomino is used exactly once. Pentominoes can be rotated and reflected. Each pentomino must contain its corresponding letter exactly once and no other letters.

Each letter appears exactly three times in the grid; two copies will be used in the Arukone and one in the Pentominoes puzzle.

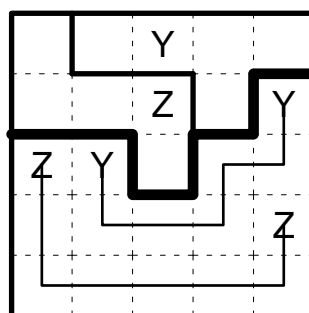
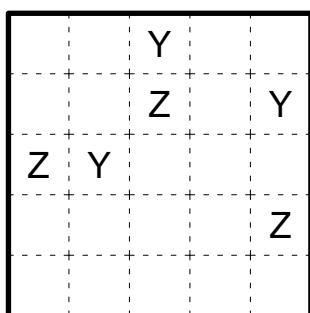

3.2 Nurikabe + Railroads

35 points

Nurikabe: Shade some cells so that all shaded cells are connected and no 2×2 square is completely shaded. Cells with numbers cannot be shaded. Each group of connected unshaded cells forms an island; islands can touch each other diagonally. Each island must contain exactly one number that is equal to the size of that island.

Railroads: Draw a closed loop into the grid that runs horizontally and vertically. The loop must cross itself at the marked cells and pass through each other cell exactly once. The numbers represent stations; there are stations from 1 to N, where N is unknown, each number exactly once. The loop cannot make a turn in a station, and along the loop the stations must be passed in order.

All crossings must be part of the Railroads puzzle.

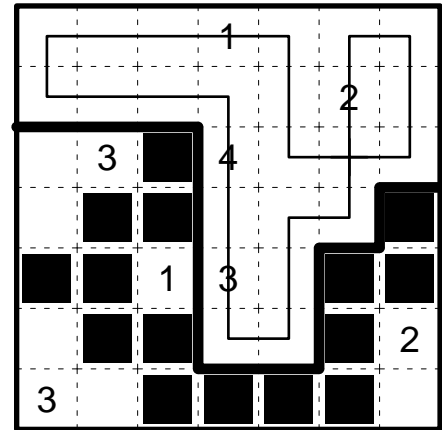
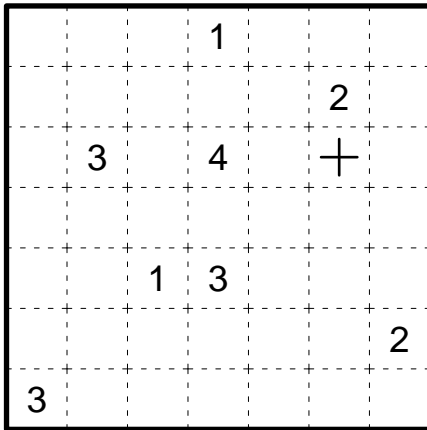

3.3 Hakyuu + Star Battle

40 points

Each outlined region belongs either completely to the Hakyuu or completely to the Star Battle puzzle.

Hakyuu: Enter numbers into the grid, so that each region of size N contains numbers from 1 to N, each number exactly once. If the same number appears multiple times within a row or column, the number itself indicates the minimum distance between these numbers: two 1s are separated by at least one other cell, two 2s are separated by at least two other cells etc. This includes Star Battle cells as well.

Star Battle: Place stars into the grid, so that there are exactly two stars in each row and column of the full grid and in each Star Battle region. The stars cannot touch each other, not even diagonally.

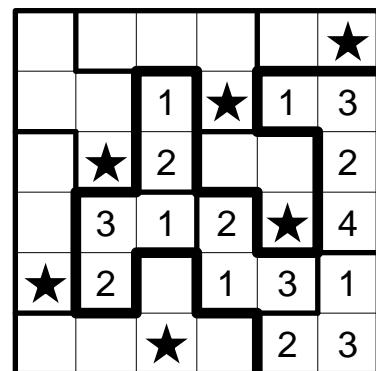
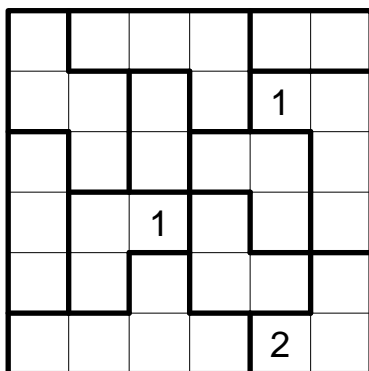

3.4 Aquarium + LITS

50 points

Each outlined region belongs either completely to the Aquarium or completely to the LITS puzzle. The numbers outside the grid are part of the Aquarium and have no meaning for the LITS puzzle.

Aquarium: Shade some cells, so that in each region at least one cell is shaded. Within a region cells that are located in the same row are either all shaded or all unshaded. When in a region a row is shaded, within the same region all cells below that row must be be shaded as well. The numbers outside the grid indicate how many Aquarium cells are shaded in the respective row or column.

LITS: Shade exactly four connected cells in each outlined region to form a tetromino. No 2×2 square can be completely shaded; this refers to cells in the LITS part only, shaded Aquarium cells are ignored here. All tetrominoes must be connected. Tetrominoes with the same shape, regardless of rotation or reflection, cannot share an edge.

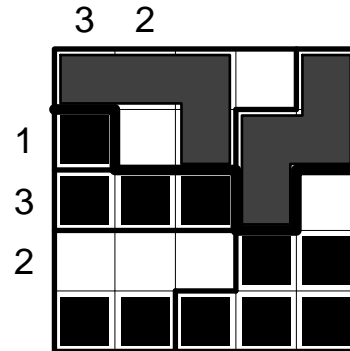
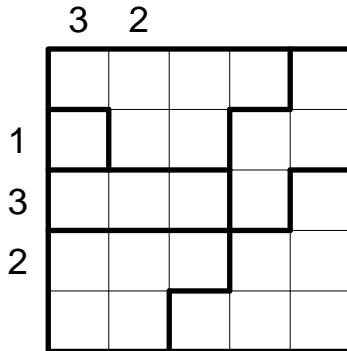

3.5 Dominoes + Slitherlink

60 points

Dominoes: Divide the grid into dominoes, so that each cell is part of exactly one domino and each domino is used exactly once. Dominoes can be rotated.

Slitherlink: Draw a closed loop along the dotted lines, that uses each grid point at most once. The numbers indicate how many edges of the respective cells are part of the loop. The loop can use the border between Dominoes and Slitherlink, but it cannot use edges that do not border any Slitherlink cell.

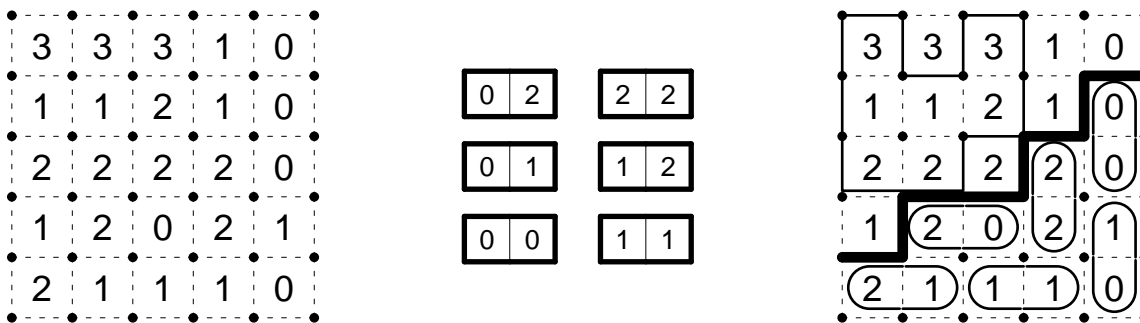

3.6 Creek + Slant

65 points

Creek: Shade some cells so that all unshaded cells are connected. Some grid points are marked with numbers; these numbers indicate how many neighbouring cells are shaded.

Slant: Enter a diagonal line into each cell. The numbers indicate how many lines start at the respective circle. The lines cannot form a closed loop anywhere in the grid.

Each number located at the border between Creek and Slant must be valid for either Creek or Slant or both.

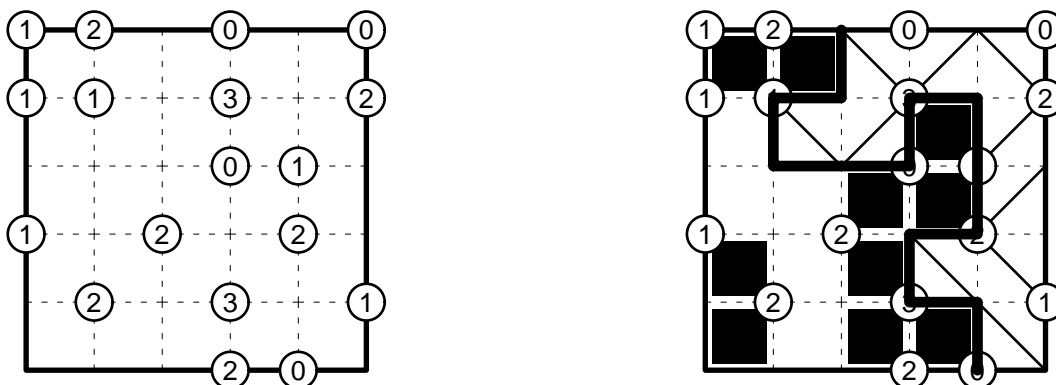

3.7 Anglers + Battleships

80 points

Each number outside the grid is part of either the Anglers or the Battleships puzzle. A number that represents an angler can still give the correct number of ship segments in the Battleships puzzle.

Anglers: Draw a line from each number (representing anglers) to a fish, so that each fish is caught by exactly one angler. The lines run horizontally and vertically, and the length of each line must be equal to the number from which it starts. Each cell must be used by exactly one line.

Battleships: Place the given ships into the grid, so that they do not touch each other, not even diagonally. Ships can be rotated. The numbers indicate how many ship segments appear in the respective row or column.

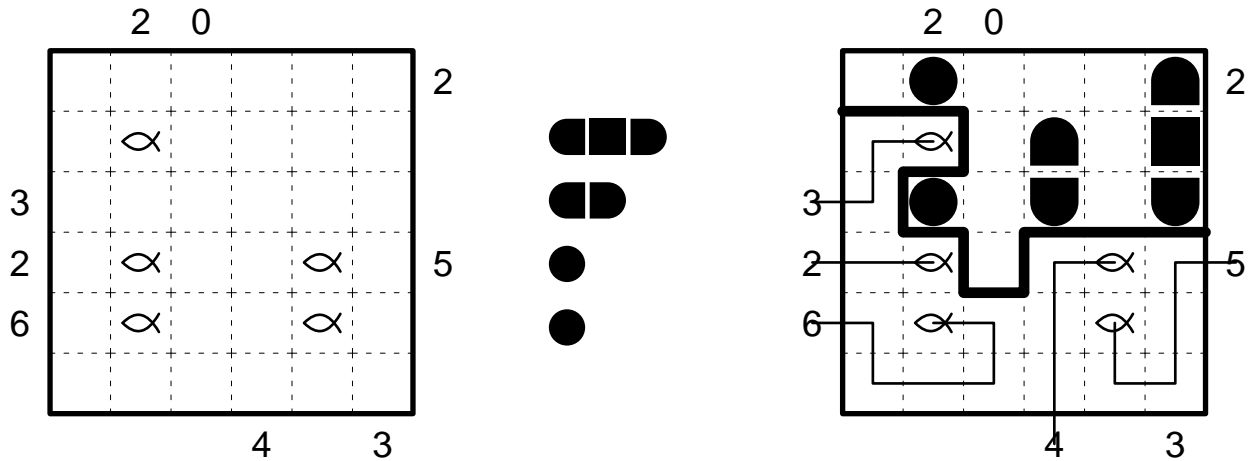

3.8 Masyu + Yin & Yang

90 points

Masyu: Draw a closed loop into the grid that runs horizontally and vertically and passes through each cell at most once. The loop must go through all cells with circles. In a cell with a black circle, the loop must make a turn and pass straight through both cells before and after the circle. In a cell with a white circle, the loop must pass straight through and make a turn in a cell before or after the circle (or both).

Yin & Yang: Enter a white or black circle into each empty cell, so that all white circles are connected, likewise all black circles. No 2×2 square can contain four circles of the same colour. This refers to Yin & Yang circles only, Masyu circles are ignored here.

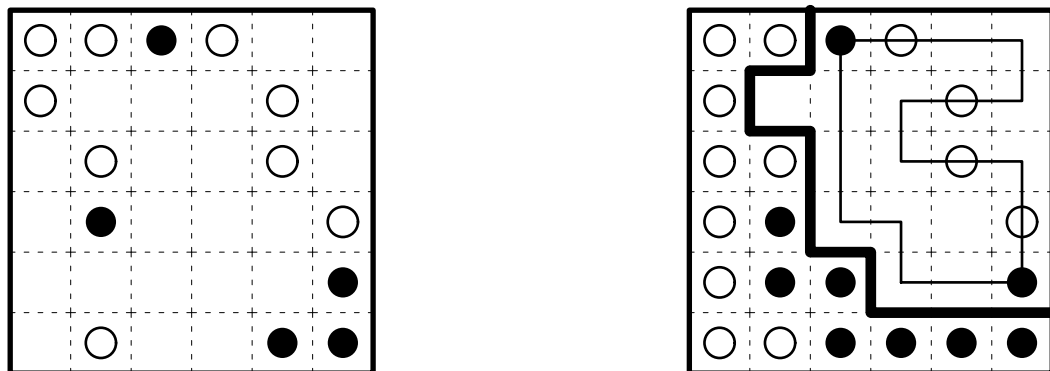

Puzzle World Cup: Round 1

45 minutes – 600 points

X1 Darts	10 points
X2 Nurikabe	15 points
X3 Arrows	15 points
X4 Minesweeper Loop	20 points
X5 Anglers	20 points
X6 Sikaku – Knapp Daneben	20 points
X7 Battleships	25 points
X8 Fillomino	25 points
X9 Cave	25 points
X10 Heyawake	25 points
X11 Four Winds	30 points
X12 Slitherlink – Hexagonal	30 points
X13 Sudoku	40 points
X14 Retrograde Area Sums	50 points
X15 Snake	60 points
X16 Nanro	60 points
X17 Hungarian Tapa	60 points
X18 Compass	70 points

X1 Darts

10 points

Find out how to score the given sum with the given number of darts. No two darts produce the same score.

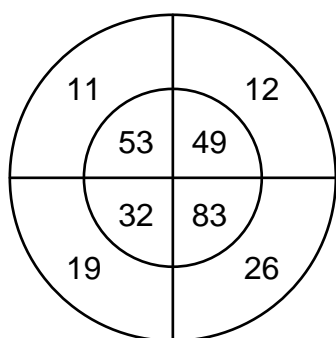

3 Darts
Sum: 100

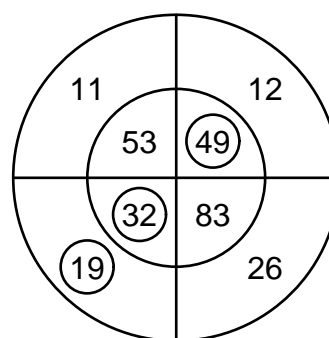

X2 Nurikabe

15 points

Shade some cells so that all shaded cells are connected and no 2×2 square is completely shaded. Cells with numbers cannot be shaded. Each group of connected unshaded cells forms an island; islands can touch each other diagonally. Each island must contain exactly one number that is equal to the size of that island.

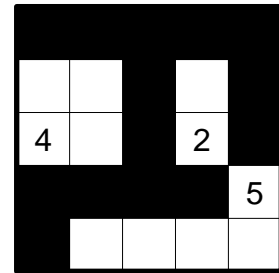
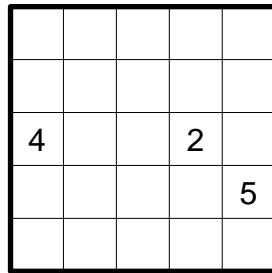

X3 Arrows

15 points

Enter an arrow into each of the outer cells, that points horizontally, vertically or diagonally to at least one interior cell. Each number indicates how many arrows are pointing to it.

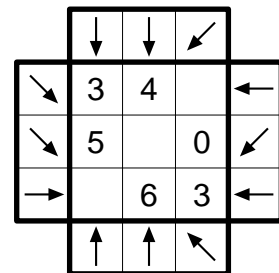
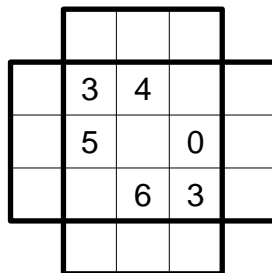

X4 Minesweeper Loop

20 points

Draw a closed loop into the grid that runs horizontally and vertically and passes through each cell at most once. The loop does not pass through numbered cells. The numbers indicate how many of the horizontally, vertically and diagonally neighbouring cells are used by the loop.

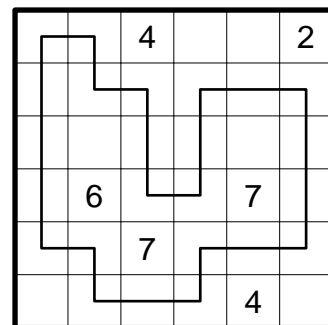
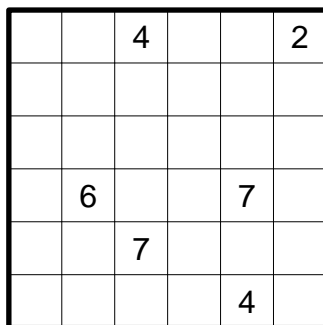

X5 Anglers

20 points

Draw a line from each number (representing anglers) to a fish, so that each fish is caught by exactly one angler. The lines run horizontally and vertically, and the length of each line must be equal to the number from which it starts. Shaded cells are not used by any lines, and each unshaded cell must be used by exactly one line.

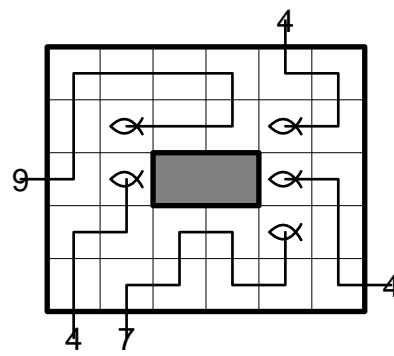
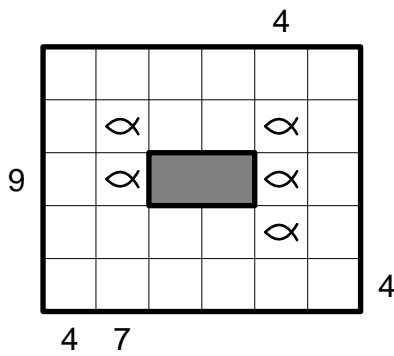

X6 Sikaku – Knapp Daneben

20 points

Divide the grid into rectangles, so that each rectangle contains exactly one number that is equal to the area of that rectangle.

However, all numbers are “Knapp Daneben”, which means that each clue number is either 1 higher or 1 lower than the actual rectangle area.

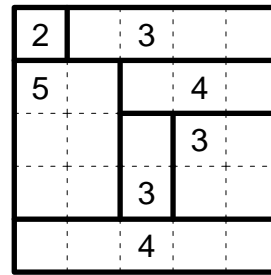
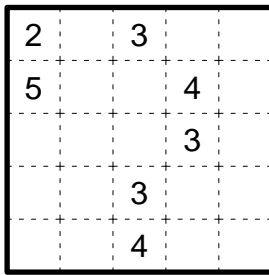

X7 Battleships

25 points

Place the given ships into the grid, so that they do not touch each other, not even diagonally. Ships can be rotated. Some ship segments may be already given. Cells marked as water cannot contain any ship segments. The numbers outside the grid indicate how many ship segments appear in the respective row or column.

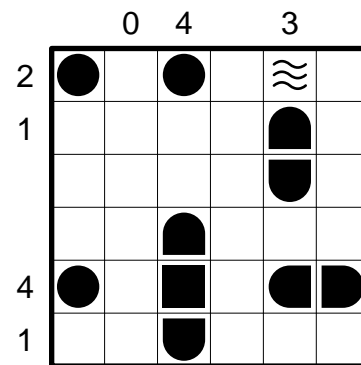
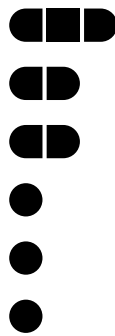
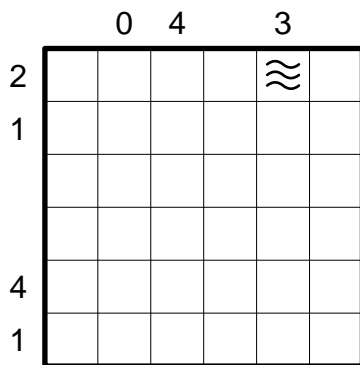

X8 Fillomino

25 points

Divide the grid into several regions, so that regions of the same size do not share an edge (they may touch diagonally). Each number indicates the size of the region it is located in. Regions may contain none, one or several numbers.

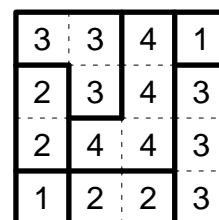
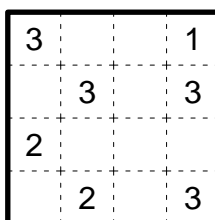

X9 Cave

25 points

Shade some cells so that all unshaded cells are connected and all shaded cells are connected to the border of the grid. Cells with numbers cannot be shaded. The numbers indicate the total count of unshaded cells that can be seen in all four directions, including the numbered cell itself.

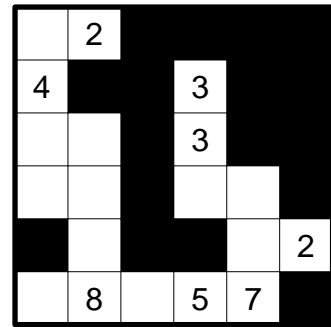
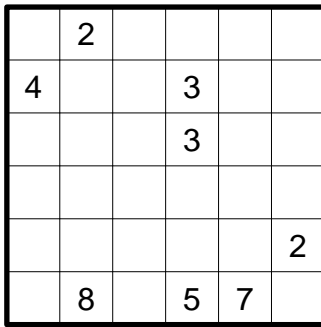

X10 Heyawake

25 points

Shade some cells, so that shaded cells are not horizontally or vertically adjacent (they can touch each other diagonally) and all unshaded cells are connected. No horizontal or vertical sequence of unshaded cells can extend over more than two outlined regions. The numbers indicate how many cells in the respective region are shaded; the numbered cell itself can be shaded but the number remains valid.

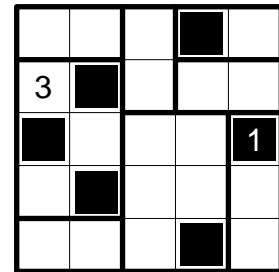
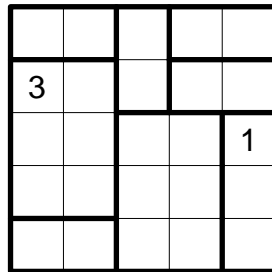

X11 Four Winds

30 points

Draw horizontal and vertical lines, starting in the numbered cells, so that each empty cell is used by exactly one line. Each number indicates how many cells are covered by lines starting in this cell, not counting the numbered cell itself. Aside from their starting cells, lines cannot enter cells with numbers.

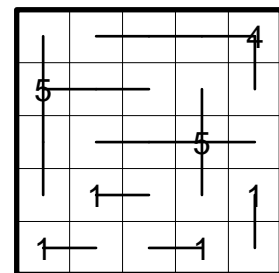
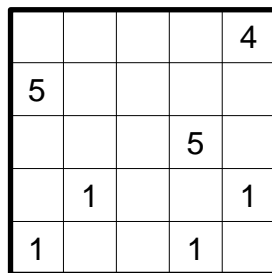

X12 Slitherlink – Hexagonal

30 points

Draw a closed loop along the dotted lines that uses each grid point at most once. The numbers indicate how many edges of the respective cells are part of the loop. Some regions consisting of more than one cell have been marked in the grid. The clue numbers in these larger regions refer to all outer edges; any line segment between two grid points is called an edge in this regard.

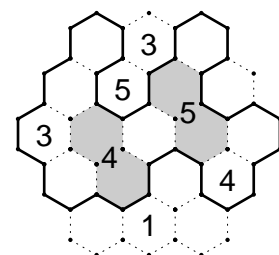
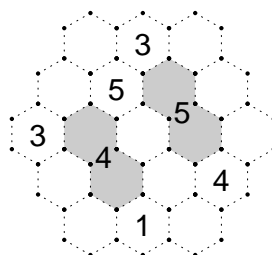

X13 Sudoku

40 points

Enter numbers from 1 to 9 into the grid, so that each number appears exactly once in each row, column and outlined 3×3 region.

	1		
			2
		3	
4			

2	1	4	3
3	4	1	2
1	2	3	4
4	3	2	1

X14 Retrograde Area Sums

50 points

Divide the grid into regions, so that each region contains exactly one clue number that is located within its region in the leftmost cell of the topmost row. Furthermore, enter numbers from the given set into the grid so that each number appears exactly once in each row and column. In each region, the sum of these numbers must equal the clue number of that region. Numbers may repeat within a region.

3			11
2			4
5		6	
9			

³ 1	2	¹¹ 4	3
² 2	3	1	⁴ 4
⁵ 4	1	⁶ 3	2
⁹ 3	4	2	1

1, 2, 3, 4

X15 Snake

60 points

Draw a snake into the grid that doesn't touch itself, not even diagonally. The snake cells are numbered in increasing order; tail (1), head (the largest number appearing in the grid) and one other snake cell are given. The numbers outside the grid indicate how many snake cells appear in the respective row or column, including those already given.

	5		4		5
3				(1)	
					(18)
2	(28)				

	5		4		5	
	(10)	(11)	(12)	(13)	(14)	(15)
3	(8)	(9)				(16)
	(7)			(2)	(1)	(17)
	(6)	(5)	(4)	(3)		(18)
2					(20)	(19)
	(28)				(22)	(21)
	(27)	(26)	(25)	(24)	(23)	

X16 Nanro

60 points

Enter numbers into some cells, so that all cells with numbers are connected and no 2×2 square is completely filled with numbers. Each region must contain at least one number. Within each region, all numbers must be the same and equal to the number of numbers within that region. Equal numbers in different regions cannot be placed in horizontally or vertically adjacent cells.

	2			
	4		4	

1	2		2	2
	2			1
1	4	4	1	4
	4		4	
	4		4	4

X17 Hungarian Tapa

60 points

Enter numbers from 1 to 5 into the grid, so that each number appears exactly once in each row and column. All cells with numbers (not including the grey clue cells) must be connected and no 2×2 square is completely filled with numbers.

The grey clue cells describe the contents of the horizontally, vertically and diagonally neighbouring cells. Each number corresponds to a contiguous group of numbers (possibly a single number) and indicates the sum of these numbers. Two such groups are separated by one or more empty or grey cells. Position and order of numbers within a clue cell are irrelevant.

5					
		1 6 7			
			2 3 7		
					13
	13				

5	2	4	3		1
	3		4	1	2
1	4	1 6 7	2		3
2		1	2 3 7	3	4
3	1	2		4	13
4	13	3	1	2	

X18 Compass

70 points

Divide the grid into regions of any sizes so that each region contains exactly one clue cell. The number in the northern sector of a clue cell indicates how many cells of its region are located north of the clue cell, regardless of their location in east-west direction. Clue numbers in the other sectors have analogous meaning.

Note: There can be clue cells without any numbers.

2 0		3 1	
		5 6	
		1 2	

2 0		3 1	
		5 6	
		1 2	

Round 4 Individual: Roundabout

30 minutes – 250 points

4.1 Roundabout 250 points
(partial solution see below)

In this round, there is only one large puzzle, consisting of six small puzzles (6×6 grids) interacting with each other via outside clue numbers.

Battleships: Place the given ships into the grid, so that they do not touch each other, not even diagonally. Ships can be rotated. Some ship segments are already given; however, all ship segments have the same shape, which means that the given segments can be part of ships of any size. Cells marked as water cannot contain any ship segments.

The numbers outside the grid indicate how many ship segments appear in the respective row or column.

Difference Sudoku: Enter numbers from 1 to 6 into the grid, so that each number appears exactly once in each row, column and outlined region.

The numbers outside the grid indicate the difference of the first two numbers in the respective row or column, seen from the respective direction.

Doppelblock Skyscrapers: Enter numbers from 1 to 4 into the grid and shade the remaining cells, so that each row and column contains each number exactly once as well as two shaded cells. The numbers represent skyscrapers of the respective height.

The numbers outside the grid indicate how many skyscrapers can be seen from the first shaded cell in the direction and up to the second shaded cell; skyscrapers not between the shaded cells are ignored. A number 0 means the shaded cells are adjacent.

First Seen Coral: Shade some cells, so that all shaded cells are connected, and all unshaded cells are connected to the border of the grid. There cannot be a 2×2 square of shaded cells.

The numbers outside the grid indicate the length of the first contiguous group of shaded cells in the respective row or column, seen from the respective direction. A number 0 means there are no shaded cells at all in that row or column.

Slitherlink: Draw a closed loop along the dotted lines that uses each grid point at most once. Numbers inside the grid indicate how many edges of the respective cells are part of the loop.

The numbers outside the grid indicate how many cells in the respective row or column are inside the loop.

Tents: Place some tents into the grid, so that they do not touch each other, not even diagonally. Each tent must be paired with a tree and placed horizontally or vertically adjacent to that tree, and there must be exactly one tent paired with each tree. Trees can be adjacent to more than one tent.

The numbers outside the grid indicate how many tents appear in the respective row or column.

Roundabout: These six puzzles are arranged in a 3×2 pattern, so that outside clues at the interior borders can refer to two puzzles. If such a position is marked with a rectangular box, then the same clue number is valid for both puzzles according to the rules above. All possible boxes are given, which means that in all positions without a box, the respective clue numbers must be different.

Scoring: If this round is completely solved, the competitor will receive 250 points. In a partially solved puzzle, competitors will receive points for interior clues (that is, outside clue numbers between two puzzles). Each clue number in a marked spot that is valid for both puzzles is worth 5 points; clue numbers in all other spots are worth 2 points. Furthermore, competitors will receive 10 points for each completely solved grid.

Note that each of the small puzzles may have more than one solution; however, the full puzzle has only one global solution which satisfies all individual rules and all interaction rules. Points are only awarded for components which coincide with the global solution!

If any of the six small puzzles are correctly solved, all clue numbers adjacent to these puzzles are automatically considered correct, and all points for these clues are awarded. This does not apply when a solution contains a mistake, however small; to receive partial points in such a situation we recommend to write down all clue numbers even when the puzzle is completely solved.

In the example on the next page, the arrangement of the six small puzzles is shown on top of the page. The arrangement of the six puzzles in the competition is different and will be shown below these instructions.

First Seen Coral	Doppelblock Skyscrapers
Difference Sudoku	Slitherlink
Battleships	Tents

2

2

3

2 4 1

0

3

4

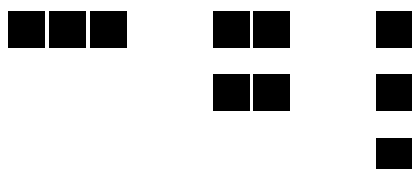

First Seen Coral	Doppelblock Skyscrapers
Difference Sudoku	Slitherlink
Battleships	Tents

2

1 2 2 5 2 3
1 1 2 5 1 2

2 1 3 3 2 1
2 0 2 1 2 3

4 1 2 1 4 1
4 1 1

2 4 1

1 0 1 1 1
4 1 4 3 3 5

4 1 4 3 3 5
0 2 0 3 0 2

2 1 1 2 1 1
4 1 1

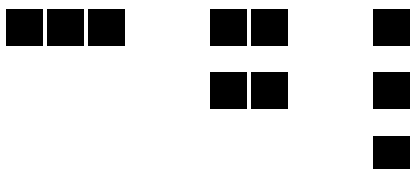

Round 5 Individual: German Style Puzzles

60 minutes – 700 points

5.1+5.2+5.3	Transporter	10+15+25	points
5.4+5.5+5.6+5.7	Compass	10+15+25+35	points
5.8+5.9+5.10+5.11	Mini Coral	10+20+30+50	points
5.12+5.13+5.14	Candles	20+30+40	points
5.15+5.16+5.17+5.18	Lookouts	10+20+40+50	points
5.19+5.20+5.21	Skyscraper Cluster	25+40+80	points
5.22+5.23	Particle Zoo	30+70	points

This round features puzzle types which (to our knowledge) have been invented by German puzzle authors. Here are some practice puzzles that can be found on the Logic Masters website:

Transporter (“Transporteur”):

<https://logic-masters.de/LM/2012/dokumente/LM2012-Endrunde-Runde3.pdf>

<https://logic-masters.de/Raetselportal/Raetsel/zeigen.php?chlang=en&id=0001QP>

Compass (“Kompass”):

<https://logic-masters.de/Raetselportal/Raetsel/zeigen.php?chlang=en&id=0002E0>

<https://logic-masters.de/Raetselportal/Raetsel/zeigen.php?chlang=en&id=0002IN>

Mini Coral (“Minikoralle”):

<https://logic-masters.de/Raetselportal/Raetsel/zeigen.php?chlang=en&id=00017S>

<https://logic-masters.de/Raetselportal/Raetsel/zeigen.php?chlang=en&id=00017V>

<https://logic-masters.de/Raetselportal/Raetsel/zeigen.php?chlang=en&id=00017X>

<https://logic-masters.de/Raetselportal/Raetsel/zeigen.php?chlang=en&id=00017Z>

Candles (“Kerzen”):

<https://logic-masters.de/Raetselportal/Raetsel/zeigen.php?chlang=en&id=00025H>

<https://logic-masters.de/Raetselportal/Raetsel/zeigen.php?chlang=en&id=000250>

<https://logic-masters.de/Raetselportal/Raetsel/zeigen.php?chlang=en&id=00025Q>

<https://logic-masters.de/Raetselportal/Raetsel/zeigen.php?chlang=en&id=00025P>

<https://logic-masters.de/Raetselportal/Raetsel/zeigen.php?chlang=en&id=00027B>

Lookouts (“Aussichtspunkte”):

<https://logic-masters.de/Raetselportal/Raetsel/zeigen.php?chlang=en&id=0001Y0>

<https://logic-masters.de/Wettbewerbe/CE/wettbewerb.php?id=44>

<https://logic-masters.de/Wettbewerbe/CE/wettbewerb.php?id=69>

Skyscraper Cluster (“Hochhausblöcke”):

<https://logic-masters.de/Raetselportal/Raetsel/zeigen.php?chlang=en&id=0000TE>

<https://logic-masters.de/Raetselportal/Raetsel/zeigen.php?chlang=en&id=0000V7>

<https://logic-masters.de/Raetselportal/Raetsel/zeigen.php?chlang=en&id=0002GC>

Particle Zoo (“Teilchenzoo”):

<https://logic-masters.de/Raetselportal/Raetsel/zeigen.php?chlang=en&id=000163>

<https://logic-masters.de/Raetselportal/Raetsel/zeigen.php?chlang=en&id=0001N8>

5.1+5.2+5.3 Transporter

10+15+25 points

Find the path of the transporter so he can deliver all transport orders.

The path must begin in the cell marked START, run horizontally and vertically and finish in the starting cell again, without using any cell more than once.

The cubes represent objects that have to be delivered to their respective destination, namely the grey circles; the letters indicate where the objects have to be delivered. Whenever the transporter reaches a cell with a cube, he picks up an object; whenever he reaches a destination, he unloads all objects with the matching letter. On his path, the transporter has to pick up and deliver all objects.

The numbers inside the cube indicate the size of each object. The transporter has a limited capacity that cannot be exceeded at any time. The capacity will be different for each puzzle and is given below each grid.

Note: It is sufficient to draw the path without direction.

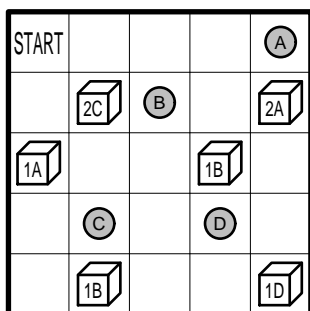

Capacity: 3

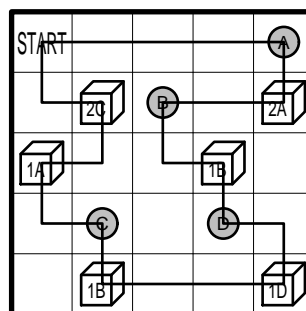

5.4+5.5+5.6+5.7 Compass

10+15+25+35 points

Divide the grid into regions of any sizes so that each region contains exactly one clue cell. The number in the northern sector of a clue cell indicates how many cells of its region are located north of the clue cell, regardless of their location in east-west direction. Clue numbers in the other sectors have analogous meaning.

Note: There can be clue cells without any numbers.

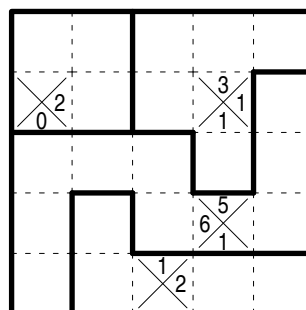
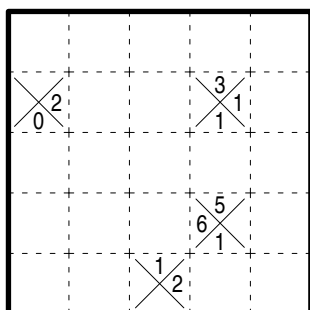

5.8+5.9+5.10+5.11 Mini Coral

10+20+30+50 points

Shade exactly two cells in each 2x2 region, so that all shaded cells are connected, all unshaded cells are connected to the border of the grid and no 2x2 square (regardless of region borders) is completely shaded. Cells with numbers cannot be shaded. The numbers indicate over how many of the original 2x2 regions the respective group of unshaded cells extends. Unshaded groups may contain none, one or several numbers.

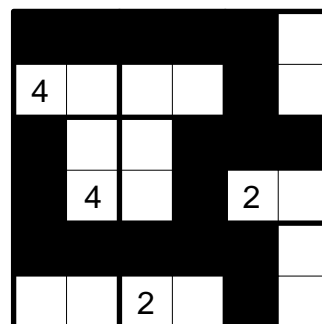
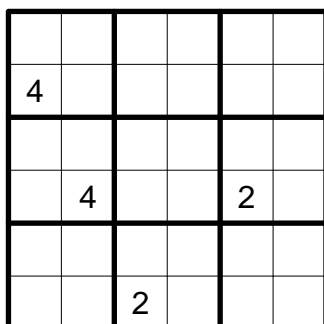

5.12+5.13+5.14 Candles

20+30+40 points

Place some lighted candles into the grid. The candles have different heights which are determined by the location of other candles nearby. A candle with no other candles in horizontally or vertically adjacent cells has height 4. For each horizontally or vertically adjacent candle, its height is reduced by 1 (the heat of nearby candles melts wax); diagonally touching candles don't affect each other. A candle of height 0 is not allowed. Candles cannot be placed in cells with numbers. The numbers indicate the total height of all candles in horizontally, vertically and diagonally neighbouring cells.

Note: It is sufficient to mark the location of the candles.

6			5
			9
3	7		

6		3		5			
	2		1		2		3
	3						9
3	7			4			

5.15+5.16+5.17+5.18 Lookouts

10+20+40+50 points

Divide the grid into regions of given sizes. Each number indicates the total number of cells within its region that can be seen horizontally or vertically from that cell, including the numbered cell itself. All numbers that are maximal within their region are given, and no other numbers are given.

5				4
				4
	3	3		
			4	4
5				

5				4
				4
	3	3		
			4	4
5				

Region sizes:
4, 5, 5, 5, 6

5.19+5.20+5.21 Skyscraper Cluster

25+40+80 points

Enter numbers into the grid, so that each region of size $N \times N$ contains numbers from 1 to N , and within a region each number appears exactly once in each row and column. These numbers represent skyscrapers of the corresponding height. Numbers bordering another grid are also clues for the adjacent grid, they indicate how many skyscrapers can be seen in the respective row or column from the respective direction. However, only clues in cells with circles are correct, clues in grey cells are always incorrect. If a corner cell borders two different grids, its clue number must be correct for both adjacent grids if the cell contains a circle, or incorrect for both adjacent grids if the cell is grey. Numbers outside the grid are correct clues for the adjacent grid.

All clue numbers refer only to the adjacent grid, only visible skyscrapers in the adjacent grid are counted.

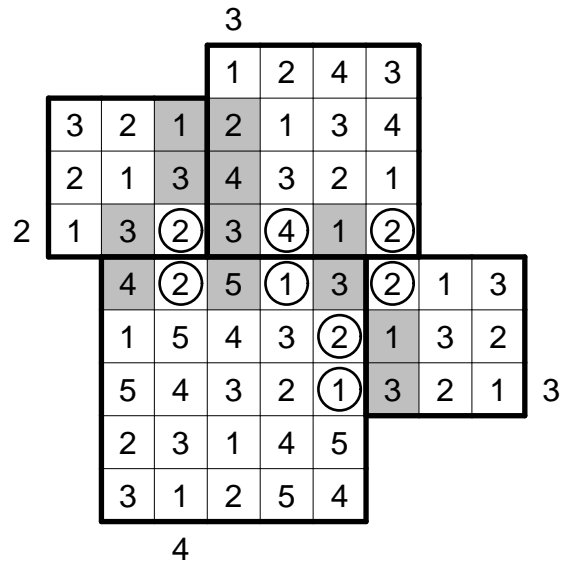
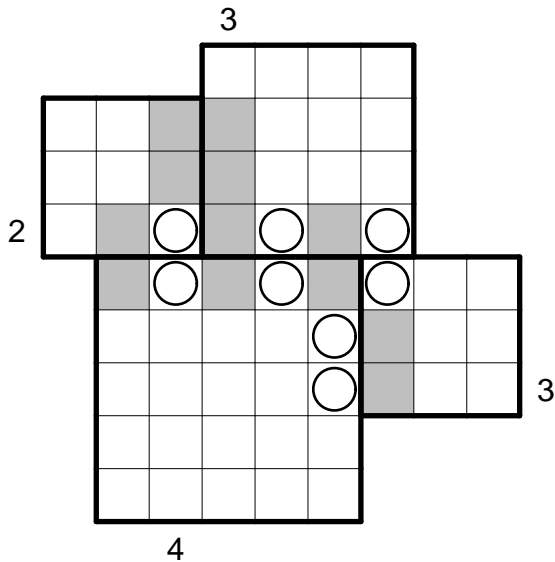

5.22+5.23 Particle Zoo

30+70 points

Find the path of a particle beam traveling through the grid.

The path enters and leaves the grid in the spots marked with arrows. It can travel in a straight line horizontally, vertically or diagonally, and in a grid point it can make a 90° turn. The path crosses itself diagonally in the spots marked with an \times , and it cannot cross itself anywhere else. Aside from this, each grid point is used at most once.

Some grid points are marked with a star. In these grid points the beam splits into two separate beams, from one diagonal beam into two horizontal/vertical beams or from one horizontal/vertical beam into two diagonal beams. See the figures below (rotations are possible). The beam cannot split anywhere else.

The numbers above and to the left of the grid indicate the number of beam segments crossing the respective row or column. The numbers below and to the right of the grid indicate how often the beam makes a 90° turn along the respective grid line, not counting the stars.

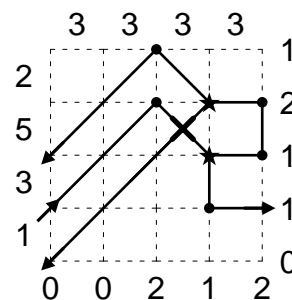
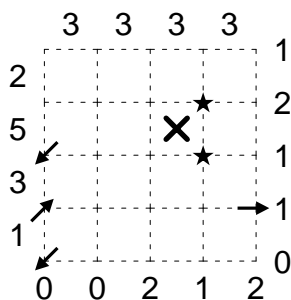
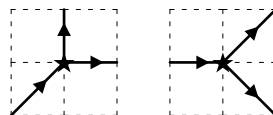

Round 6 Team: Patches

45 minutes – 2000 points

Cross the Streams	500 points
(partial solution:	2.1 points per shaded cell)
Hydra	500 points
(partial solution:	2.5 points per shaded cell)
Nurikabe	500 points
(partial solution:	1.8 points per shaded cell)
Tapa	500 points
(partial solution:	1.9 points per shaded cell)

This round consists of four shading puzzles (Cross the Streams, Hydra, Nurikabe, Tapa), that interact via some additional regions, the patches. The patches have different shapes and no symmetry. Each patch appears exactly once in each puzzle; the placement of the patches is different for each puzzle, furthermore the patches may be rotated (but not reflected). For each patch, the pattern of shaded and unshaded cells must be identical in all four puzzles. Some patches have holes, these are not part of the patches; cells in such holes can be shaded in some puzzles and unshaded in others. In puzzles with interior clues, there will be no clues on the patches. In the puzzles the patches are shown as light grey regions, this is just for better visibility and does not influence the shading in terms of the puzzles.

In all four puzzles, all shaded cells are horizontally and vertically interconnected and no 2×2 square is completely shaded.

Cross the Streams: Shade some cells so that all shaded cells are connected and no 2×2 square is completely shaded. The clues outside the grid describe the contents of the respective row or column. Each number corresponds to a contiguous group of shaded cells, the number indicates the length of that group. A question mark (?) corresponds to a contiguous group of shaded cells as well, but of unknown length. Two such groups are separated by one or more unshaded cells. An asterisk (*) corresponds to an unknown number of such groups, possibly none at all, of any lengths. For each row and column, the clues are given in correct order.

Hydra: Locate a hydra in the grid. The hydra is a snake that starts with one tail and branches into multiple heads. Starting in the tail, its cells are numbered in ascending order; after branching, both parts of the hydra get the same numbers. For example, if the hydra branches in cell 2, both subsequent cells are numbered as 3 and so on. The given numbers inside the grid are the tail (1) and all heads. The hydra cannot branch in the tail or in any of its heads, it can branch in any other cell.

In accordance with the other puzzles in this round, the hydra cells including its tail and heads shall be shaded. All shaded cells must be connected, and no 2×2 square is completely shaded. The hydra cannot form any “rings”, and aside from its branchings it cannot touch itself, not even diagonally; in other words, all unshaded cells must be connected to the border of the grid.

The numbers outside the grid indicate the number of hydra cells in the respective row or column, including tail and heads.

Nurikabe: Shade some cells so that all shaded cells are connected and no 2×2 square is completely shaded. Cells with numbers cannot be shaded. Each group of connected unshaded cells forms an island; islands can touch each other diagonally. Each island must contain exactly one number that is equal to the size of that island.

Tapa: Shade some cells so that all shaded cells are connected and no 2×2 square is completely shaded. Cells with numbers cannot be shaded. The numbers indicate how many of the horizontally, vertically and diagonally neighbouring cells are shaded: each number corresponds to a contiguous group of shaded cells, two such groups are separated by one or more unshaded cells. Position and order of the numbers within a cell are irrelevant.

Teams will receive the puzzles on separate sheets of A3 paper. Teams will also receive one set of patches, cut out on cardboard. You can use these for solving, however only the paper sheets will be handed in. The next pages show an example with solution.

Scoring: For each completely and correctly solved puzzle a team will receive 500 points. If a solution is incomplete or partly incorrect, teams will receive partial points according to the number of shaded cells in the grid. The following formulae will be used:

Cross the Streams: $\text{Score} = 2.1 \times ((\text{Number of correctly shaded cells}) - (\text{number of incorrectly shaded cells}))$

Hydra: $\text{Score} = 2.5 \times ((\text{Number of correctly shaded cells}) - (\text{number of incorrectly shaded cells}))$

Nurikabe: $\text{Score} = 1.8 \times ((\text{Number of correctly shaded cells}) - (\text{number of incorrectly shaded cells}))$

Tapa: $\text{Score} = 1.9 \times ((\text{Number of correctly shaded cells}) - (\text{number of incorrectly shaded cells}))$

For each puzzle, the score is rounded down to the nearest integer.

If this formula yields a negative result for any puzzle, a team will score 0 points for this puzzle. The scores for the other three puzzles will not be affected.

Example (with two patches):

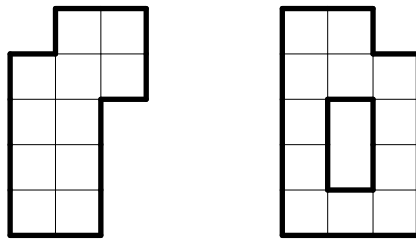

Tapa

Hydra

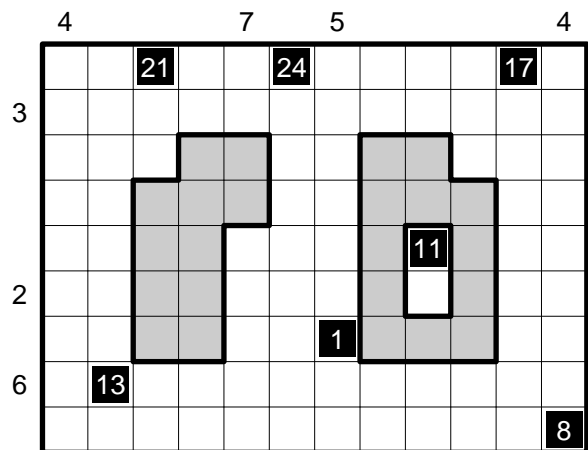
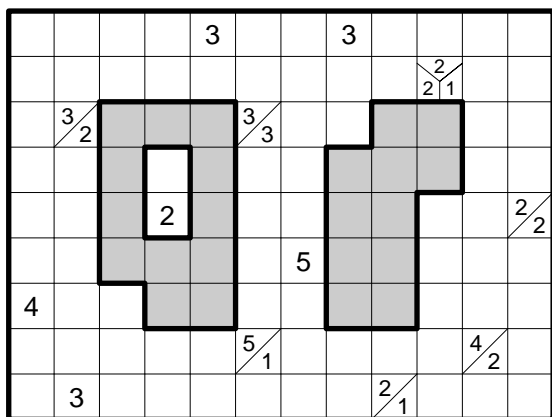

Nurikabe

Cross the Streams

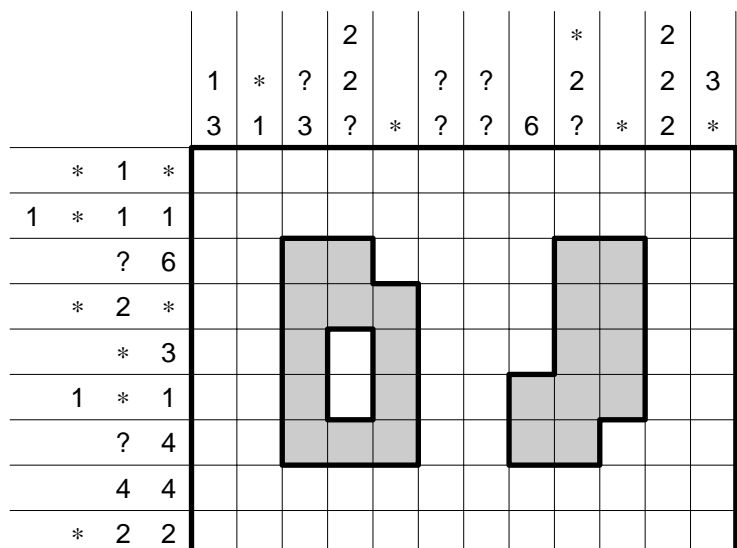
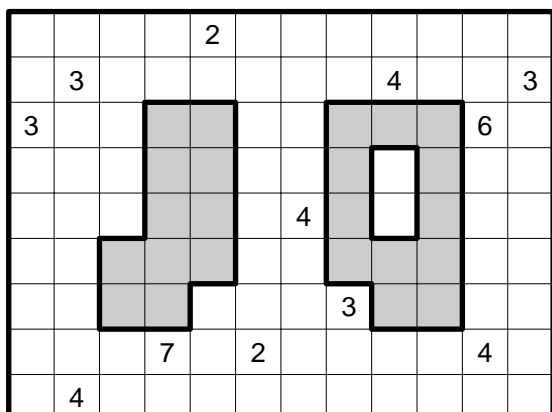

Example solution:

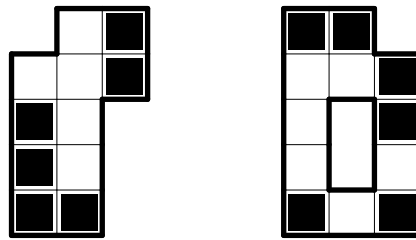

Tapa

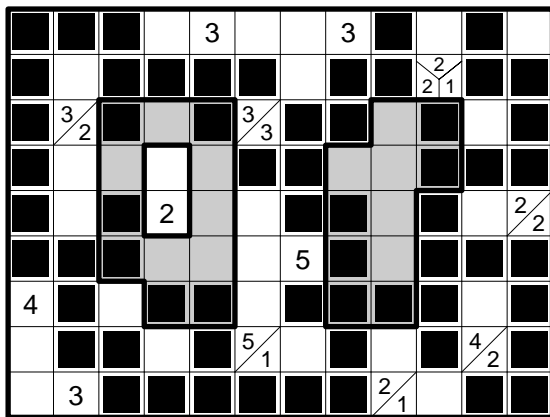

Hydra

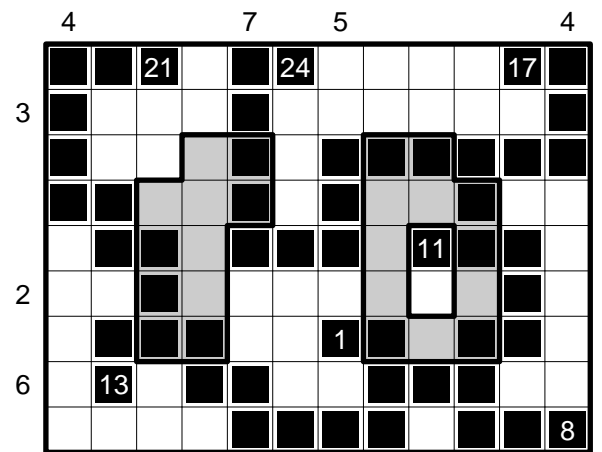

Nurikabe

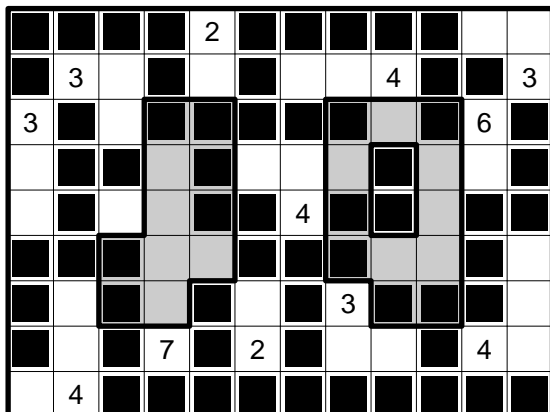

Cross the Streams

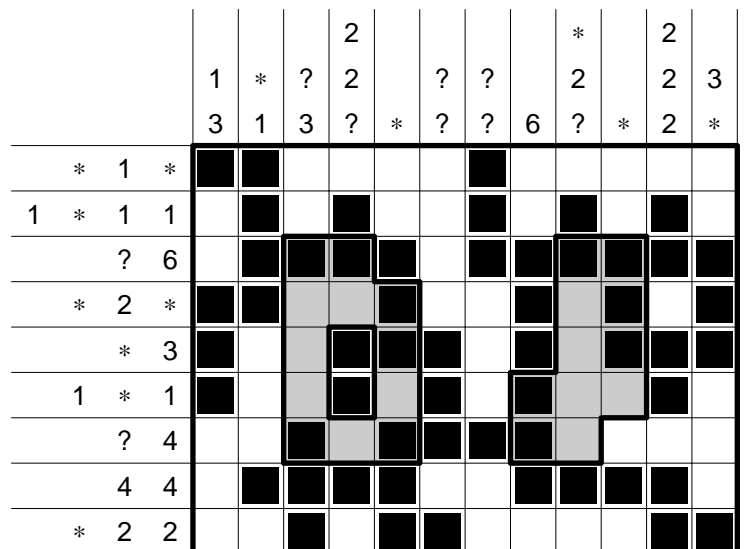

Round 7 Team: Worms

45 minutes – 1800 points

Worms	1800 points
(partial solution:	20 points per correctly filled region)
4× Easy as 1234(5)	0 points
4× Futoshiki	0 points
4× Fuzuli	0 points
4× Hakyuu	0 points
4× Kakuro	0 points
4× Mathrax	0 points
4× Top Heavy Number Place	0 points
4× Trid	0 points

This round consists of one very large main puzzle and a number of auxiliary puzzles.

The rules for the main puzzle are:

Worms: Enter numbers into the grid, so that each region of size N contains numbers from 1 to N , each number exactly once. Within each region, consecutive numbers must be placed in horizontally or vertically adjacent cells. Equal numbers in different regions cannot be placed in horizontally, vertically or diagonally neighbouring cells.

The main puzzle has a unique solution, but it is very hard. Teams can solve auxiliary puzzles to make it easier.

The main puzzle has the shape of a map of Germany. Some cells where major cities are located are marked. There is one auxiliary puzzle for each city. Teams can use these auxiliary puzzles to find out which numbers go into the respective cells in the main puzzle. There are 32 auxiliary puzzles, eight puzzle types with four puzzles each:

Easy as ...: Enter numbers from 1 to 4 respectively from 1 to 5 (two puzzles for each variant) into the grid, so that each number appears exactly once in each row and column. The numbers outside the grid indicate the first number in the respective row or column, seen from the respective direction.

Futoshiki: Enter numbers from 1 to 6 into the grid, so that each number appears exactly once in each row and column. The inequality signs in the grid indicate which of two adjacent numbers is greater.

Fuzuli: Enter numbers from 1 to 4 into the grid, so that each number appears exactly once in each row and column. There can be no 2×2 square containing four numbers anywhere in the grid.

Hakyuu: Enter numbers into the grid, so that each region of size N contains numbers from 1 to N , each number exactly once. If the same number appears multiple times within a row or column, the number itself indicates the minimum distance between these numbers: each pair of equal numbers N in the same row or column must be separated by at least N other cells between them.

Kakuro: Enter a number from 1 to 9 into each white cell. The numbers in grey cells indicate the sums of the numbers in the horizontally or vertically adjacent “words”. Within each word, no number can appear more than once.

Mathrax: Enter numbers from 1 to 6 into the grid, so that each number appears exactly once in each row and column. Some grid points contain a clue consisting of a number and an arithmetic operator. The clue number must be the result of the given operator being applied to a pair of diagonally opposite adjacent cells, and it must be valid for both such pairs of cells. If a grid point is marked with an E (“even”) or O (“odd”), then all four adjacent cells must contain even respectively odd numbers.

Top Heavy Number Place: Enter numbers from 1 to 5 into the grid, so that each number appears exactly once in each row and column. Whenever two vertically adjacent cells both contain numbers, the greater number must be placed above the smaller number.

Trid: Enter numbers from 1 to 7 into the circles, so that no number appears more than once in a row (in all three directions). Clues inside the grid indicate the sum of the numbers in the three adjacent circles.

Each auxiliary puzzle comes on a separate sheet of paper. At the top left, the name of the city and the puzzle type are given. The top right corner shows the numbers used in this puzzle. For your convenience the bottom left shows a small map with the location of the city highlighted.

In each auxiliary puzzle, one or several cells are marked with letters. The number in the main puzzle results from the numbers in these marked cells. If there is just one marked cell, this number is transferred into the respective cell of the main puzzle, otherwise the number in the main puzzle is the result of a simple arithmetic operation, either $X = A + B + C$ or $X = A + B - C$. Empty cells are treated as a 0. How to calculate the city cell in the main puzzle is shown at the bottom right of each auxiliary puzzle.

Teams will receive both the main puzzle and all auxiliary puzzles at their team table. Regarding the auxiliary puzzles, teams are free to employ any strategy they like. However, teams can score points only for the main puzzle; the auxiliary puzzles will be discarded. If the main puzzle is completely solved without any mistakes, a team will receive 1800 points. Otherwise, each correctly filled region will yield 20 points.

Note: For this round, no alternative notation can be used, only numbers in cells will be accepted. It is fine to enter numbers from different directions, though.

Example of the main puzzle (including marked city cells):

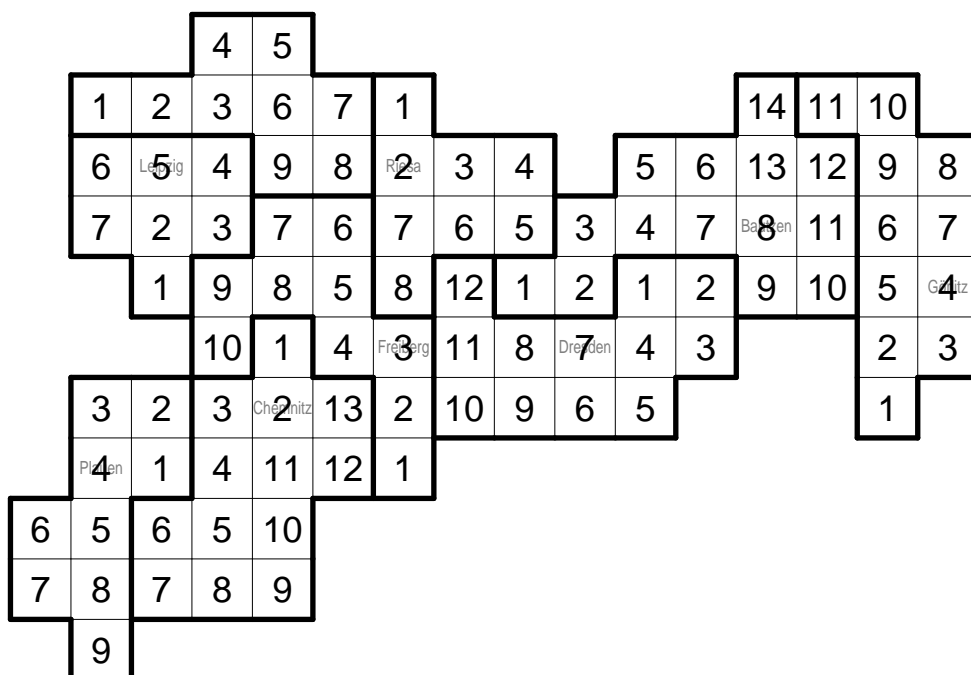
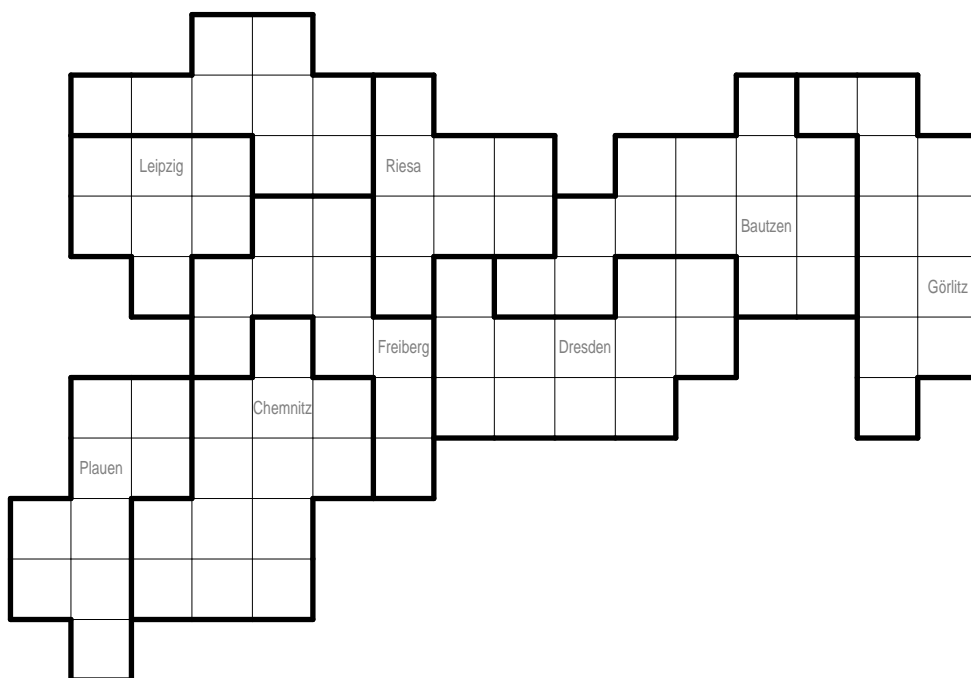

Mathrax:

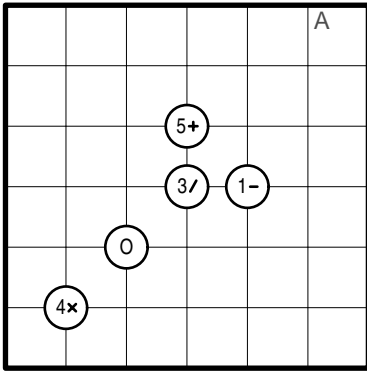

Leipzig = A

Fuzuli:

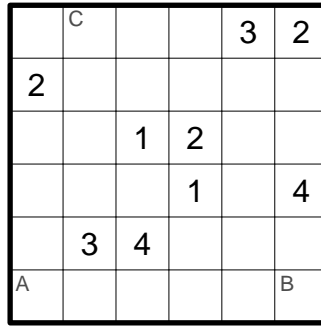

Riesa = A + B + C

Top Heavy ... (1-4):

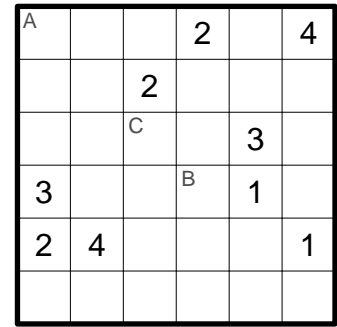

Freiberg = A + B - C

Easy as 1234:

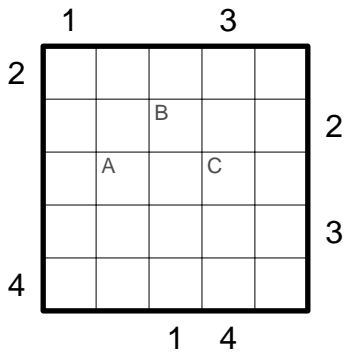

Görlitz = A + B + C

Hakuyu:

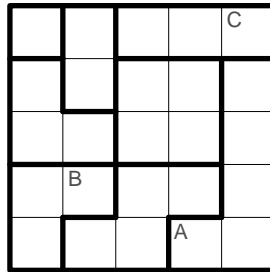

Bautzen = A + B + C

Kakuro:

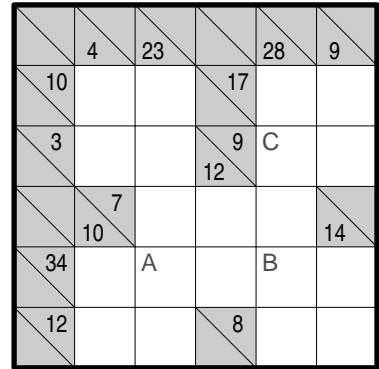

Chemnitz = A + B - C

Trid (1-6):

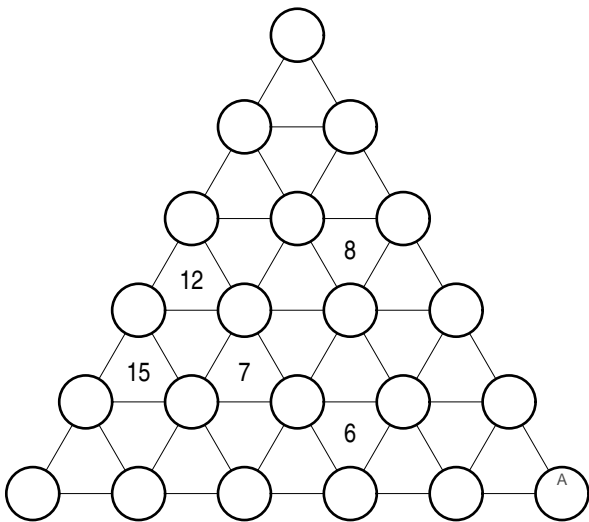

Plauen = A

Futoshiki (1-5):

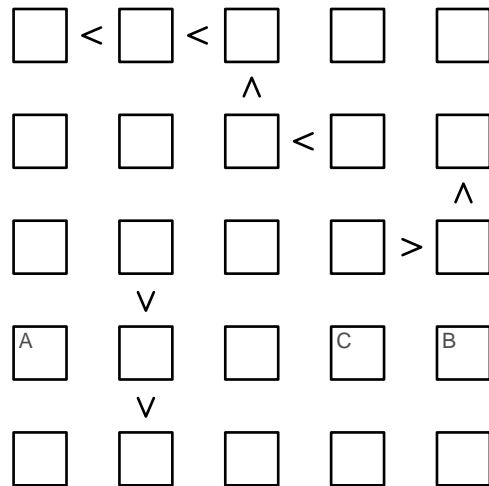

Dresden = A + B - C

Mathrax:

6	3	1	2	4	A5
5	6	4	3	1	2
3	4	2	5+	1	5
1	5	3	3/	6	1-
2	1	0			
4	2	6	5	3	1
4	4x				

Leipzig = 5

Fuzuli:

	C1		4	3	2
2	4	3		1	
4		1	2		3
3	2		1		4
	3	4		2	1
A1		2	3	4	B

Riesa = 2

Top Heavy ... (1-4):

A	1	3	2		4
		2	1	4	3
4	2	C1		3	
3			B4	1	2
2	4		3		1
1	3	4		2	

Freiberg = 3

Easy as 1234:

	1		3		
2		2	4	3	1
	1	4	B3	2	
	3	A	2	C1	4
	2	1		4	3
4	4	3	1		2
			1	4	

Görlitz = 4

Hakuyu:

1	2	3	1	C2
2	1	4	3	1
1	3	1	2	4
3	B1	2	1	3
2	4	3	A5	2

Bautzen = 8

Kakuro:

	4	23		28	9
10	3	7		17	9
3	1	2		9	C8
	7	1	4	2	14
34	7	A4	8	B6	9
12	3	9		8	3

Chemnitz = 2

Trid (1-6):

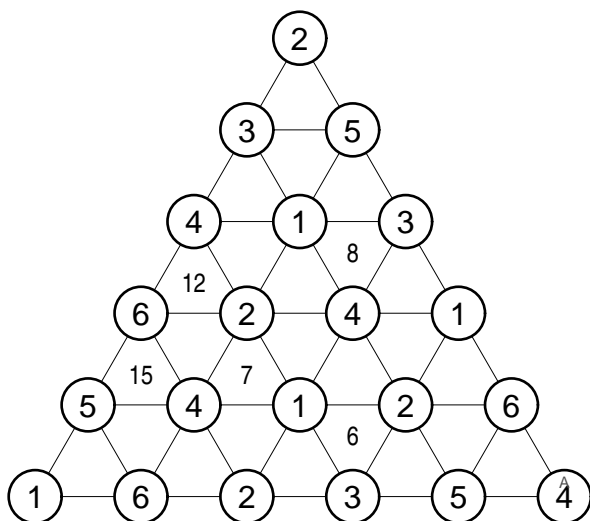

Plauen = 4

Futoshiki (1-5):

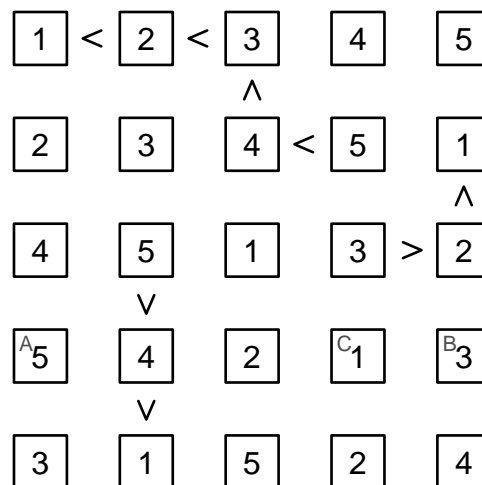

Dresden = 7

Round 8 Individual: Twilight

60 minutes – 600 points

8.1 Easy as ABC	25 points
8.2 BACA	40 points
8.3 Slitherlink	25 points
8.4 Standard / Touching Slitherlink	60 points
8.5 Tapa	20 points
8.6 Twilight Tapa	60 points
8.7 Magnets	40 points
8.8 Twilight Magnets	70 points
8.9 Pentopia	40 points
8.10 Twilight Pentopia	90 points
8.11 Cave	30 points
8.12 Twilight Cave	100 points

8.1 Easy as ABC

25 points

Enter letters A, B, C into the grid, so that each letter appears exactly once in each row and column. The letters outside the grid indicate the first letter in the respective row or column, seen from the respective direction.

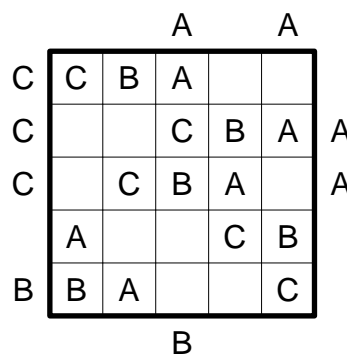
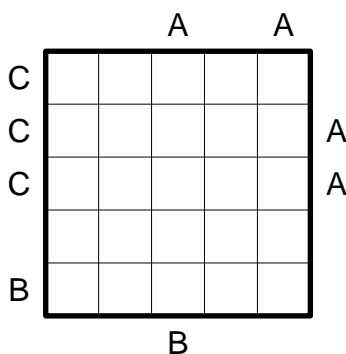

8.2 BACA

40 points

Shade some cells and enter letters A, B, C into the grid, so that each letter appears exactly once in each row and column and all other cells are shaded. Cells with given letters can either be shaded or keep the given letter, however no other letter can be entered in such cells. The letters outside the grid indicate the first letter in the respective row or column, seen from the respective direction. The numbers outside the grid describe the shaded cells in the respective row or column: Each number corresponds to a contiguous group of shaded cells, the number indicates the length of that group. Two such groups are separated by one or more letters. The numbers appear in the correct order.

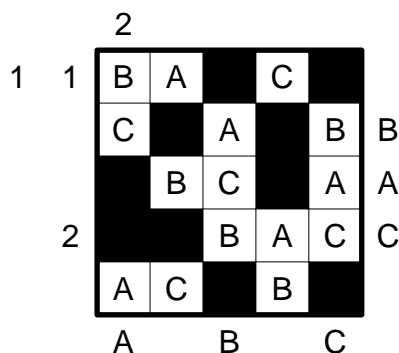
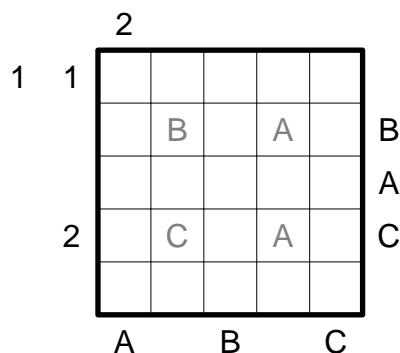

8.3 Slitherlink

25 points

Draw a closed loop along the dotted lines that uses each grid point at most once. The numbers indicate how many edges of the respective cells are part of the loop.

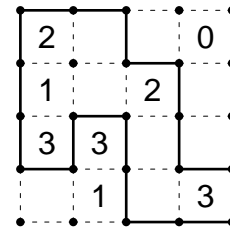
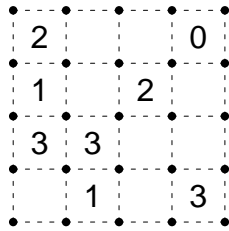

8.4 Standard / Touching Slitherlink

60 points

Draw a closed loop along the dotted lines that uses each grid point at most once. Numbers that are inside the loop indicate how many edges of the respective cells are part of the loop, as in a standard Slitherlink. Numbers that are outside the loop indicate how often the loop visits the respective cells. In this context, a “visit” is defined as a contiguous section of the loop traveling on the boundary of the cell in question, including the possibility of just a single corner point; two such sections are considered separate visits if the loop leaves the boundary of the cell between them.

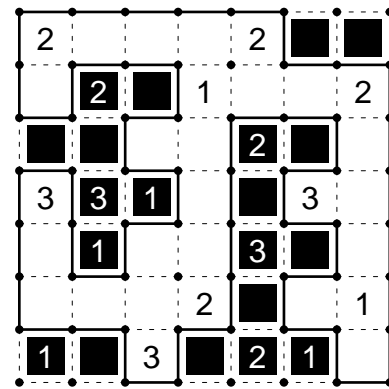
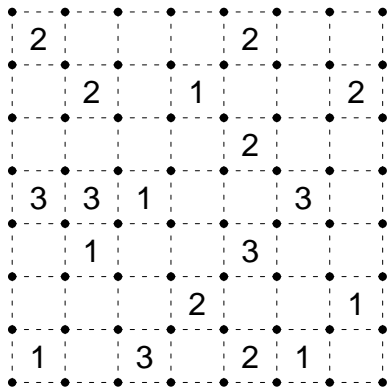

8.5 Tapa

20 points

Shade some cells so that all shaded cells are connected and no 2×2 square is completely shaded. Cells with numbers cannot be shaded. The numbers indicate how many of the horizontally, vertically and diagonally neighbouring cells are shaded: each number corresponds to a contiguous group of shaded cells, two such groups are separated by one or more unshaded cells. Position and order of the numbers within a cell are irrelevant.

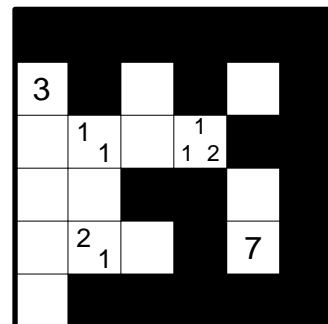
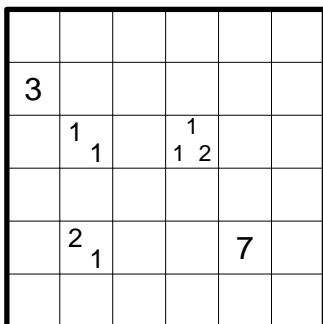

8.6 Twilight Tapa

60 points

Shade some cells so that all shaded cells are connected and no 2×2 square is completely shaded. Cells with numbers can be shaded.

Numbers in an unshaded cell indicate how many of the horizontally, vertically and diagonally neighbouring cells are shaded: each number corresponds to a contiguous group of shaded cells, two such groups are separated by one or more unshaded cells.

Numbers in a shaded cell indicate how many of the horizontally, vertically and diagonally neighbouring cells are unshaded: each number corresponds to a contiguous group of unshaded cells, two such groups are separated by one or more shaded cells.

Position and order of the numbers within a cell are irrelevant.

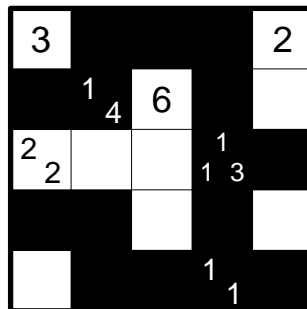
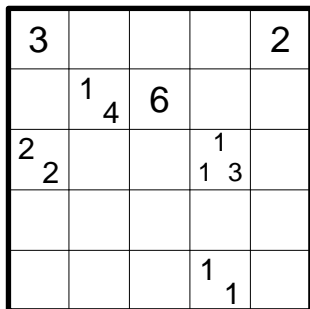

8.7 Magnets

40 points

Fill the grid with neutral (shaded) and magnetic plates. Each magnetic plate has two poles, represented by + and - signs. Poles of the same type cannot be horizontally or vertically adjacent. The numbers indicate how many poles of the corresponding type appear in the respective row or column.

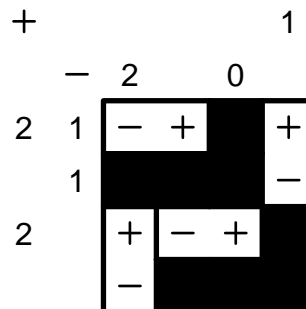
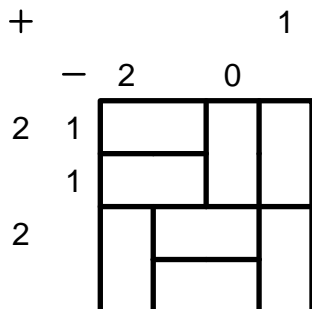

8.8 Twilight Magnets

70 points

Fill the grid with neutral (shaded) and magnetic plates. Each magnetic plate has two poles, represented by + and - signs. Poles of the same type cannot be horizontally or vertically adjacent. The numbers indicate how many poles of the corresponding type appear in the respective row or column.

Plates with given symbols can either be shaded or keep their poles. Their polarity cannot be reversed.

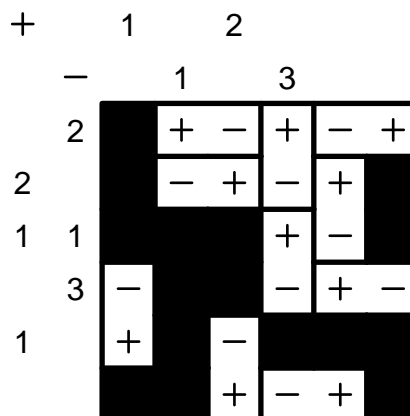
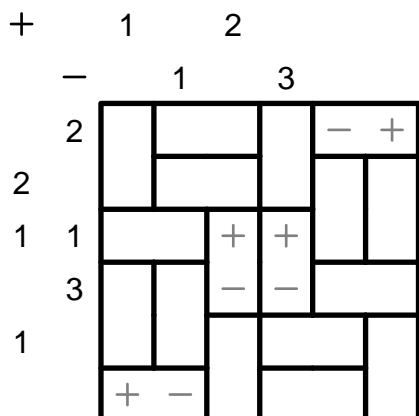

8.9 Pentopia

40 points

Place some pentominoes into the grid, so that they do not touch each other, not even diagonally. Pentominoes can be rotated and reflected; no pentomino can be used more than once. Pentominoes cannot overlap cells with arrows. If a cell contains one or more arrows, the arrows indicate the directions of the nearest pentomino cells. If there is no arrow in a specific direction, then the nearest pentomino cell is farther away, or there may be no such cell in this direction at all.

For a list of all pentominoes, see the glossary on page 6. In the puzzle booklet a list of pentominoes will be given.

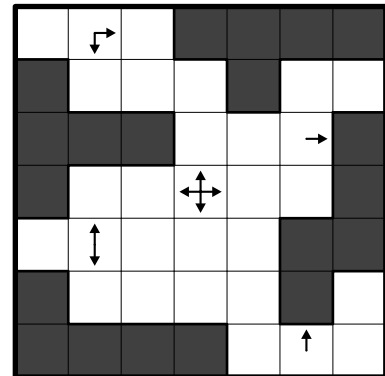
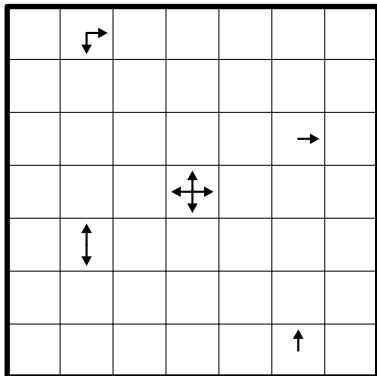

8.10 Twilight Pentopia

90 points

Place some pentominoes into the grid, so that they do not touch each other, not even diagonally. Pentominoes can be rotated and reflected; no pentomino can be used more than once. Pentominoes can overlap cells with arrows.

If a cell containing one or more arrows is not part of any pentomino, the arrows indicate the directions of the nearest pentomino cells. If there is no arrow in a specific direction, then the nearest pentomino cell is farther away, or there may be no such cell in this direction at all.

If a cell containing one or more arrows is part of a pentomino, the arrows indicate the direction of the nearest cells that are not part of any pentomino. If there is no arrow in a specific direction, then the nearest cell that is not part of any pentomino is farther away, or there may be no such cell in this direction at all.

For a list of all pentominoes, see the glossary on page 6. In the puzzle booklet a list of pentominoes will be given.

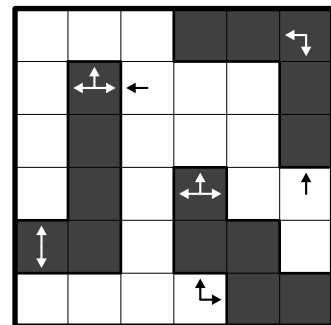
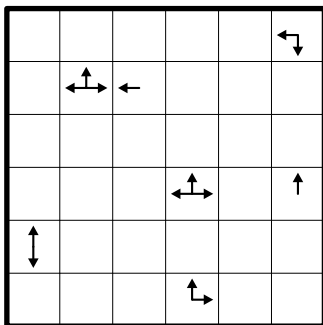

8.11 Cave

30 points

Shade some cells so that all unshaded cells are connected and all shaded cells are connected to the border of the grid. Cells with numbers cannot be shaded. The numbers indicate the total count of unshaded cells that can be seen in all four directions, including the numbered cell itself.

	2				
4			3		
			3		
					2
	8		5	7	

	2				
4			3		
			3		
					2
	8		5	7	

8.12 Twilight Cave

100 points

Shade some cells so that all unshaded cells are connected and all shaded cells are connected to the border of the grid. Cells with numbers can be shaded.

Numbers in unshaded cells indicate the total count of unshaded cells that can be seen in all four directions, including the numbered cell itself.

Numbers in shaded cells indicate the size of the group of connected shaded cells they are part of. A group of shaded cells may contain none, one or several numbers.

4			2		
	5				3
		2	6		2
4		6			3
					5
		5	4		2

4			2		
	5				3
		2	6		2
4		6			3
					5
		5	4		2

Round 9 Individual: Miniatures

30 minutes – 250 points

9.1 Sikaku	5 points
9.2 Hitori	5 points
9.3 Tents	5 points
9.4 Star Battle	5 points
9.5 Skyscrapers	10 points
9.6 Dominoes	10 points
9.7 Yajilin	10 points
9.8 Increasing Distances	10 points
9.9 Zigzag	10 points
9.10 Doppelblock	10 points
9.11 Magnets	15 points
9.12 Nurikabe	15 points
9.13 Minesweeper	15 points
9.14 Killer Sudoku	15 points
9.15 Battleships	15 points
9.16 Crossword	15 points
9.17 Dissection	20 points
9.18 Snake	20 points
9.19 Kakuro	20 points
9.20 Slitherlink	20 points

All puzzles in this round are smaller than usual, similar to the size of these examples.

9.1 Sikaku

5 points

Divide the grid into rectangles, so that each rectangle contains exactly one number that is equal to the area of that rectangle.

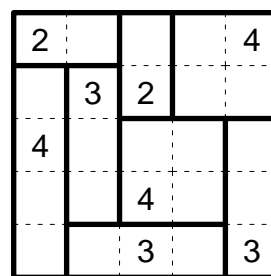
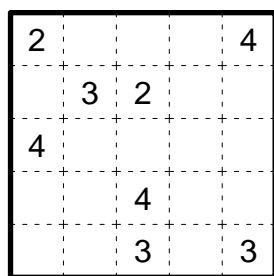

9.2 Hitori

5 points

Shade some cells, so that shaded cells are not horizontally or vertically adjacent (they can touch each other diagonally) and all unshaded cells are connected. Within each row and column, no number can appear more than once in unshaded cells.

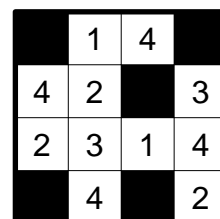
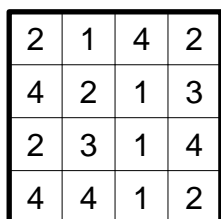

9.3 Tents

5 points

Place some tents into the grid, so that they do not touch each other, not even diagonally. Each tent must be paired with a tree and placed horizontally or vertically adjacent to that tree, and there must be exactly one tent paired with each tree. Trees can be adjacent to more than one tent. The numbers outside the grid indicate how many tents appear in the respective row or column.

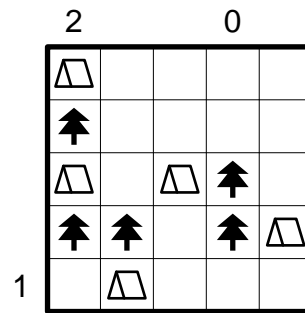
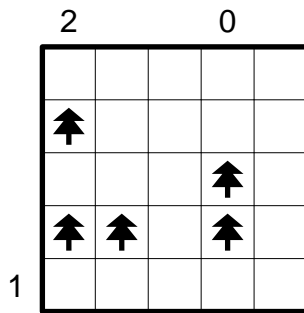

9.4 Star Battle

5 points

Place stars into the grid, so that there is exactly one star in each row, column and outlined region. The stars cannot touch each other, not even diagonally.

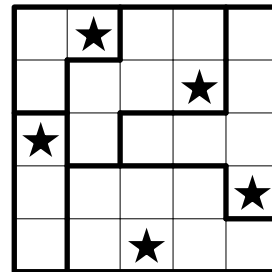
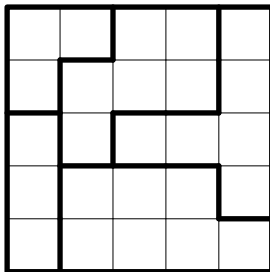

9.5 Skyscrapers

10 points

Enter numbers from 1 to 4 into the grid, so that each number appears exactly once in each row and column. These numbers represent skyscrapers of the corresponding height. The numbers outside the grid indicate how many skyscrapers can be seen in the respective row or column from the respective direction. Smaller skyscrapers are hidden behind higher ones.

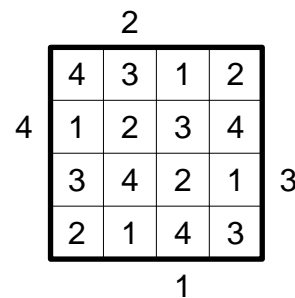
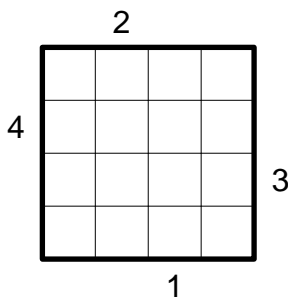

9.6 Dominoes

10 points

Divide the grid into dominoes, so that each cell is part of exactly one domino and each domino is used exactly once. Dominoes can be rotated.

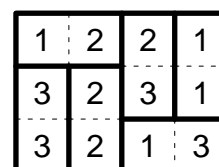
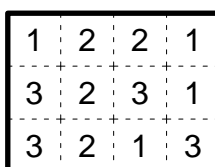

9.7 Yajilin

10 points

Shade some cells and draw a closed loop that runs horizontally and vertically and passes through each cell except the shaded cells and the clue cells exactly once. Clue cells cannot be shaded, and shaded cells cannot be horizontally or vertically adjacent (they can touch each other diagonally). The numbers indicate how many shaded cells appear in the specified direction.

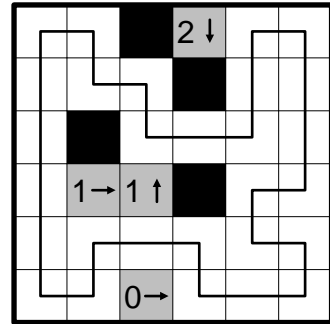
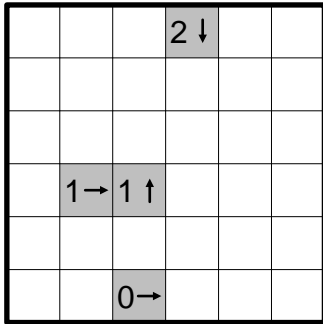

9.8 Increasing Distances

10 points

Place numbers from 1 to 8 into the circles, so that each number is used exactly once. The geometrical distances between consecutive numbers must increase: the distance between 1 and 2 must be smaller than the distance between 2 and 3, the latter being smaller than the distance between 3 and 4 etc.

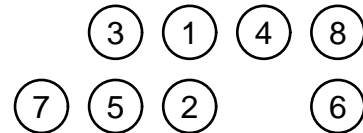
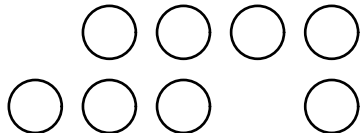

9.9 Zigzag

10 points

Find a path from the top left cell to the bottom right cell that runs horizontally, vertically and diagonally and passes through each cell exactly once. The path cannot cross itself. The letters along the path must form the password shown below the grid repeatedly.

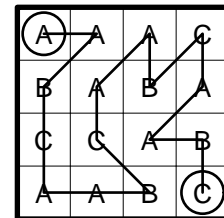
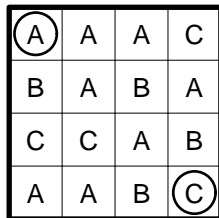

Password: AABC

9.10 Doppelblock

10 points

Enter numbers from 1 to 3 into the grid and shade the remaining cells, so that each row and column contains each number exactly once as well as two shaded cells. The numbers outside the grid indicate the sum of the numbers between the two shaded cells in the respective row or column. A sum of 0 means that the shaded cells are adjacent.

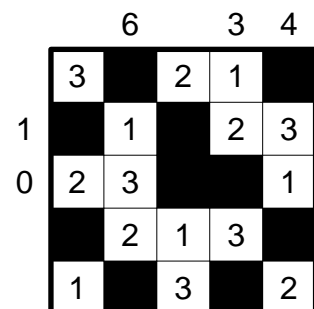
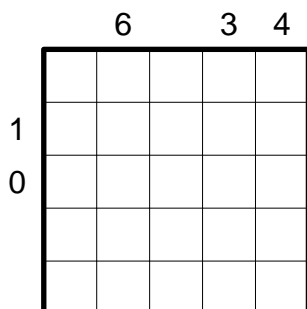

9.11 Magnets

15 points

Fill the grid with neutral (shaded) and magnetic plates. Each magnetic plate has two poles, represented by + and - signs. Poles of the same type cannot be horizontally or vertically adjacent. The numbers indicate how many poles of the corresponding type appear in the respective row or column.

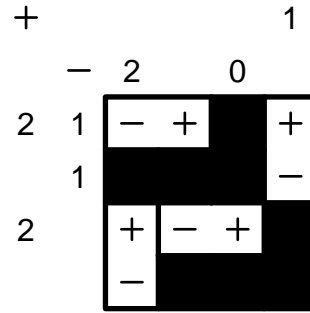
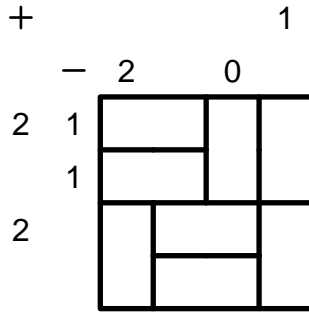

9.12 Nurikabe

15 points

Shade some cells so that all shaded cells are connected and no 2x2 square is completely shaded. Cells with numbers cannot be shaded. Each group of connected unshaded cells forms an island; islands can touch each other diagonally. Each island must contain exactly one number that is equal to the size of that island.

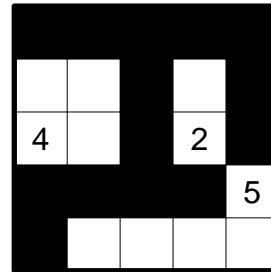
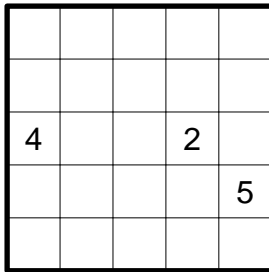

9.13 Minesweeper

15 points

Place the given number of mines into the grid. Mines cannot be placed in cells with numbers. The numbers indicate how many mines can be found in horizontally, vertically and diagonally neighbouring cells.

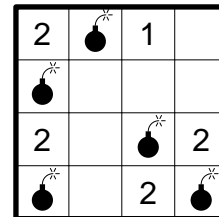
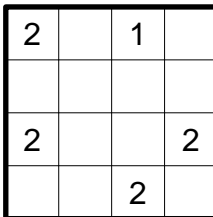

5 mines

9.14 Killer Sudoku

15 points

Enter numbers from 1 to 4 into the grid, so that each number appears exactly once in each row, column and outlined region. Within each small cage, the numbers must add up to the sum given in the top left cell, and no number can appear more than once.

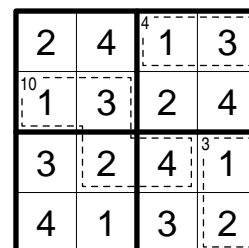
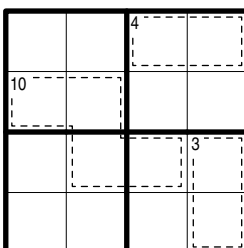

9.15 Battleships

15 points

Place the given ships into the grid, so that they do not touch each other, not even diagonally. Ships can be rotated. Some ship segments may be already given. Cells marked as water cannot contain any ship segments. The numbers outside the grid indicate how many ship segments appear in the respective row or column.

	0	4	3	
2			⊞	
1				
4				
1				

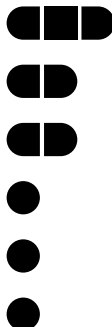

	0	4	3	
2	●	●	⊞	
1			⊞	
		⊞		
4	●	■	⊞	●
1		⊞		

9.16 Crossword

15 points

Enter the given words into the grid, so that they can be read horizontally from left to right or vertically from top to bottom. All words must be interconnected, and each word must be used exactly once. No other words of two or more letters may arise.

Note: Due to the symmetry of the grid, there are two solutions (or rather, there is one solution that can be mirrored along the diagonal).

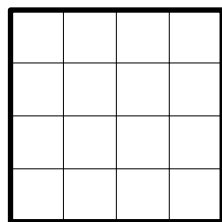

- AADD
- BBAA
- BCBC
- DCCD

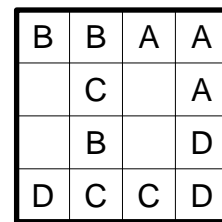

9.17 Dissection

20 points

Divide the grid into three congruent pieces, using horizontal, vertical and diagonal lines. Cells can be cut in half by a diagonal line, other ways to cut a cell into smaller parts are not allowed. The pieces must have identical shape and size, but they can be rotated and reflected.

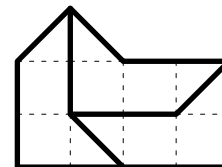
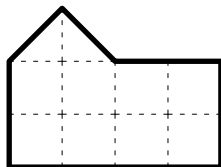

9.18 Snake

20 points

Draw a snake into the grid that doesn't touch itself, not even diagonally. The numbers indicate how many snake cells appear in the respective row or column. Head and tail of the snake are not given.

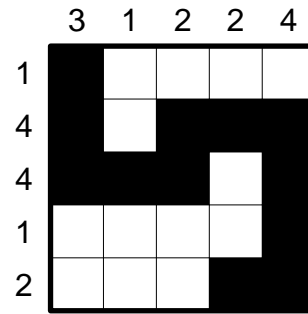
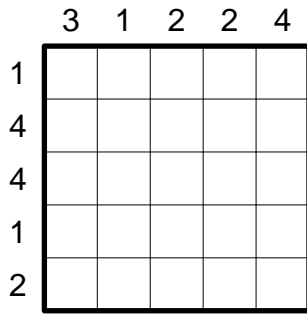

9.19 Kakuro

20 points

Enter a number from 1 to 9 into each white cell. The numbers in grey cells indicate the sums of the numbers in the horizontally or vertically adjacent "words". Within each word, no number can appear more than once.

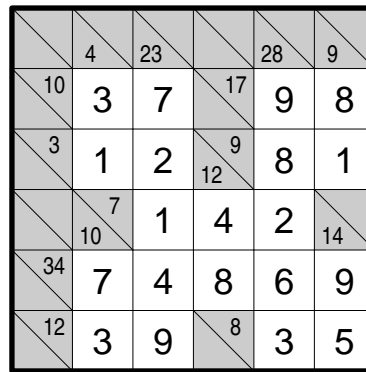
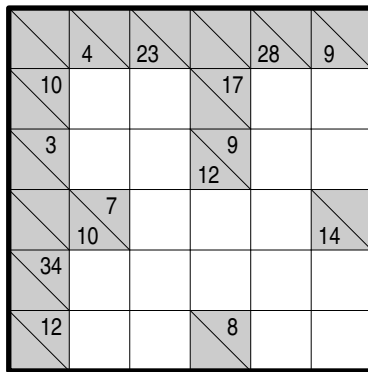

9.20 Slitherlink

20 points

Draw a closed loop along the dotted lines that uses each grid point at most once. The numbers indicate how many edges of the respective cells are part of the loop.

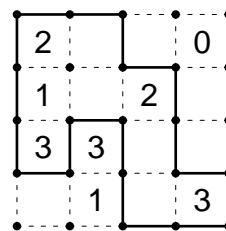
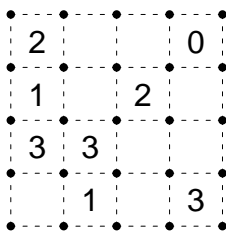

Round 10 Individual: WPC 28

75 minutes – 850 points

10.1 Minesweeper	20 points
10.2 Simple Loop	40 points
10.3 Tents	50 points
10.4 Multi Arukone	80 points
10.5 Square Dissection	100 points
10.6 Pentominous Nontouching	120 points
10.7 Regional Hexominoes	130 points
10.8 Bosnian Road	150 points
10.9 Overlapping Squares	160 points

All puzzles in this round are larger than usual. Specifically, since this is the 28th World Puzzle Championship, all puzzles in this round will have a 28×28 grid.

10.1 Minesweeper

20 points

Place the given number of mines into the grid. Mines cannot be placed in cells with numbers. The numbers indicate how many mines can be found in horizontally, vertically and diagonally neighbouring cells.

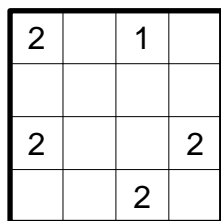

5 mines

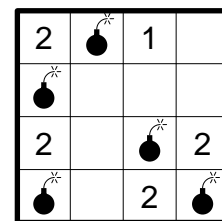

10.2 Simple Loop

40 points

Draw a closed loop into the grid that runs horizontally and vertically and passes through each white cell exactly once. Shaded cells cannot be used by the loop.

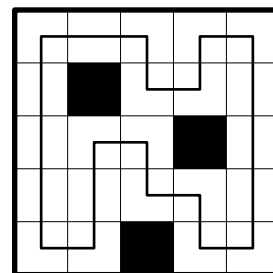
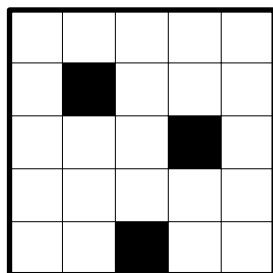

10.3 Tents

50 points

Place some tents into the grid, so that they do not touch each other, not even diagonally. Each tent must be paired with a tree and placed horizontally or vertically adjacent to that tree, and there must be exactly one tent paired with each tree. Trees can be adjacent to more than one tent. The numbers outside the grid indicate how many tents appear in the respective row or column.

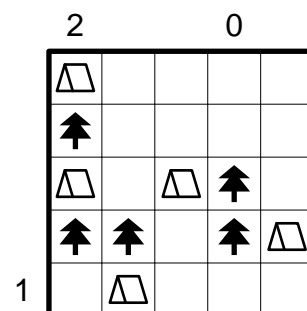
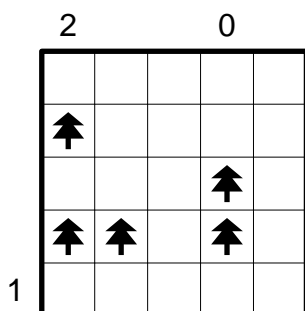

10.4 Multi Arukone

80 points

Connect pairs of identical characters (letters or digits) by a line that runs horizontally and vertically. No cell can be used by more than one such line; some cells may remain unused. There are more than two copies of some characters (always an even number), in these cases it is part of the puzzle to find out which pairs to connect.

Note: There are no digits 0 or 1 in the grid.

A		A	2		
	3				
		2		A	
	3	B			
				B	2
A	2				

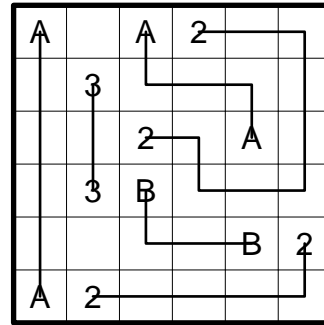

10.5 Square Dissection

100 points

Divide the grid (except the shaded cells) into squares of sizes 1×1 through 10×10 , so that each size is used exactly twice. Shaded cells are not used by any square, and each unshaded cell must be part of exactly one square.

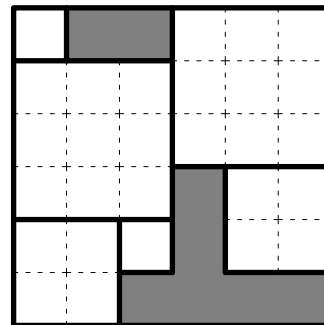
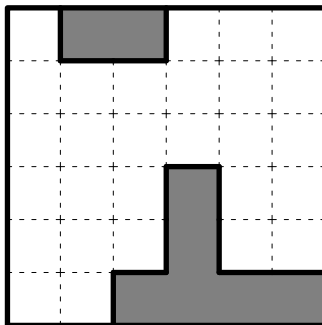

10.6 Pentominous Nontouching

120 points

Divide the grid (except the shaded cells) into pentominoes, so that pentominoes with the same shape (regardless of rotation or reflection) do not touch each other, not even diagonally. Shaded cells are not part of any pentomino. Pentominoes can be rotated and reflected, and each pentomino can be used any number of times (possibly zero). Each letter inside the grid must be part of a pentomino with the shape associated with that letter.

For a list of all pentominoes, see the glossary on page 6. In the puzzle booklet a list of pentominoes will be given.

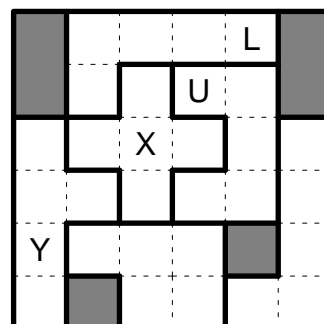
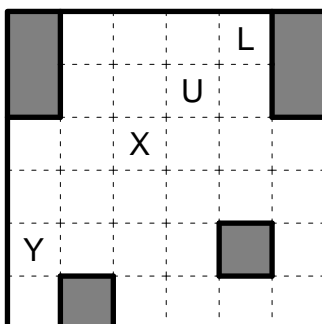

10.7 Regional Hexominoes

130 points

Place all 35 hexominoes into the grid, so that they do not touch each other, not even diagonally. Hexominoes can be rotated and reflected. Each hexomino must be used exactly once. Each hexomino must lie completely in an outlined region, and each region must contain exactly one hexomino.

The example uses only 4 out of 35 hexominoes. In the puzzle booklet the full set will be shown.

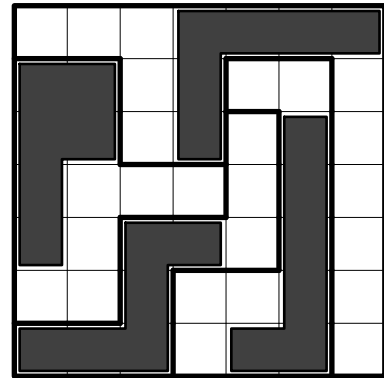
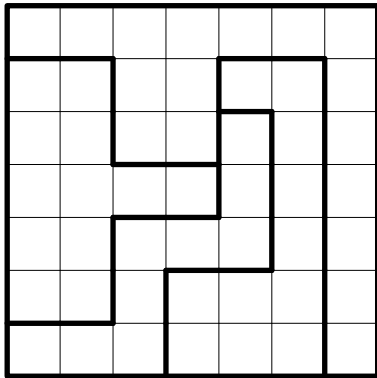

10.8 Bosnian Road

150 points

Draw a closed loop into the grid that runs horizontally and vertically and passes through each cell at most once. The loop cannot pass through cells with numbers. The loop cannot touch itself, not even diagonally. The numbers indicate how many horizontally, vertically and diagonally neighbouring cells are used by the loop.

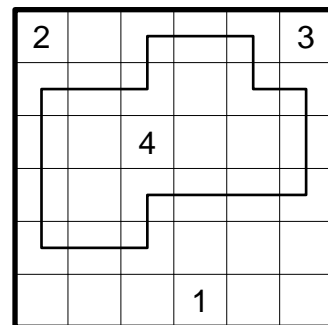
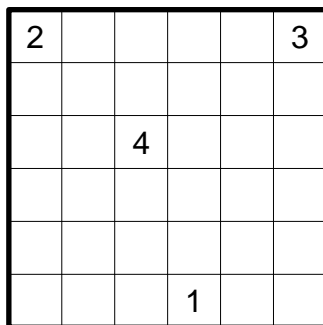

10.9 Overlapping Squares

160 points

Draw squares of sizes 1×1 through 15×15 into the grid, exactly one of each size, so that their vertices lie on grid points and their edges run along grid lines. The edges of these squares do not overlap (they may cross each other), and squares do not share vertices. Each number indicates the sum of the lengths of the edges of all squares that contain the cell with that number.

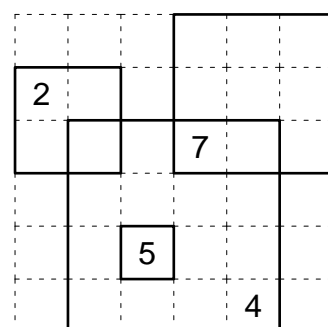
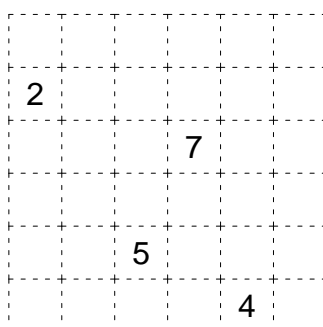

Puzzle World Cup: Round 2

45 minutes – 600 points

Y1 Doppelblock	15 points
Y2 Hidato	20 points
Y3 Tents	25 points
Y4 Gaps – Knapp Daneben	30 points
Y5 Slitherlink / Cave	35 points
Y6 Statue Park	35 points
Y7 Terra X	40 points
Y8 Congruence Loop	45 points
Y9 Chatroom	50 points
Y10 Total Castle Wall	50 points
Y11 Underground	55 points
Y12 Pyramid 0-9	60 points
Y13 Deformable Masyu	70 points
Y14 Summon	70 points

Y1 Doppelblock

15 points

Enter numbers from 1 to 4 into the grid and shade the remaining cells, so that each row and column contains each number exactly once as well as two shaded cells. The numbers outside the grid indicate the sum of the numbers between the two shaded cells in the respective row or column. A sum of 0 means that the shaded cells are adjacent.

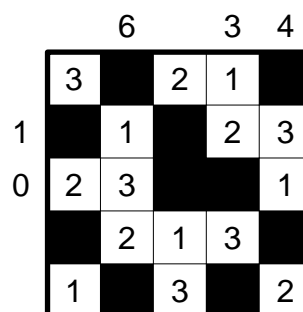
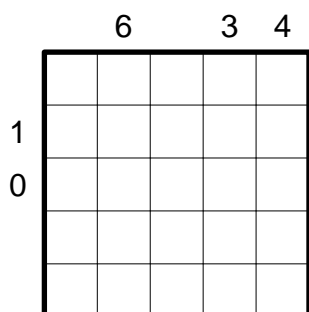

Y2 Hidato

20 points

Enter a number into each empty cell, so that, including the given numbers, all numbers from 1 to 49 appear exactly once. Consecutive numbers must be placed in horizontally, vertically or diagonally neighbouring cells.

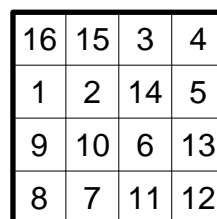
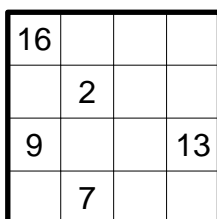

Y3 Tents

25 points

Place some tents into the grid, so that they do not touch each other, not even diagonally. Each tent must be paired with a tree and placed horizontally or vertically adjacent to that tree, and there must be exactly one tent paired with each tree. Trees can be adjacent to more than one tent. The numbers outside the grid indicate how many tents appear in the respective row or column.

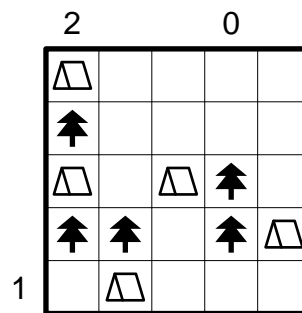
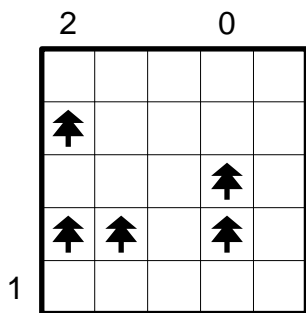

Y4 Gaps – Knapp Daneben

30 points

Place stars into the grid, so that there are exactly two stars in each row and column. The stars do not touch each other, not even diagonally. The numbers outside the grid indicate the number of empty cells between the two stars in the respective row or column.

However, all numbers are “Knapp Daneben”, which means that each clue number is either 1 higher or 1 lower than the actual number of empty cells.

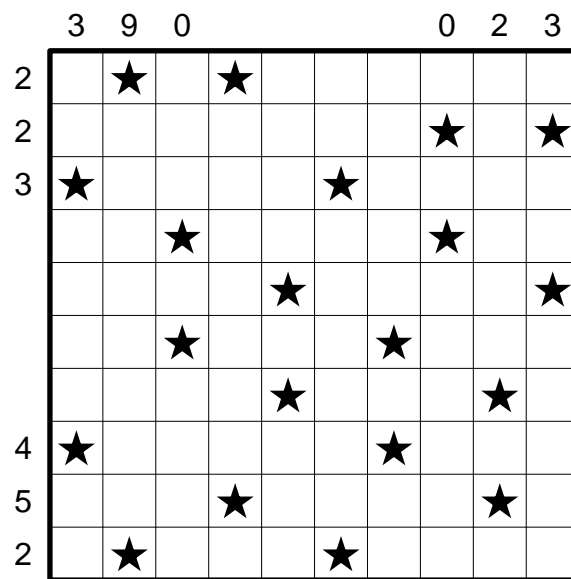
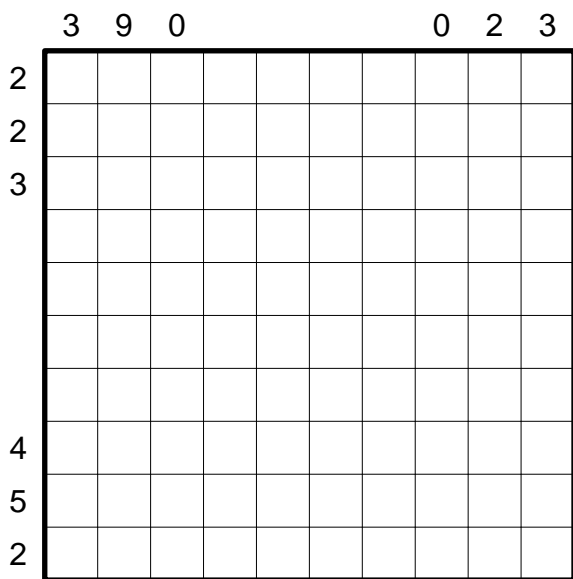

Y5 Slitherlink / Cave

35 points

Draw a closed loop along the dotted lines that uses each grid point at most once. Numbers that end up outside the loop are Slitherlink clues, they indicate how many edges of the respective cells are part of the loop. Numbers that end up inside the loop are Cave clues, they indicate the total count of cells inside the loop that can be seen in all four directions, including the numbered cell itself.

Note: Instead of drawing the loop, it is sufficient to mark all cells as inside or outside the loop.

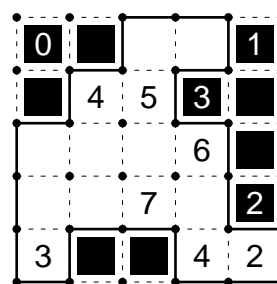
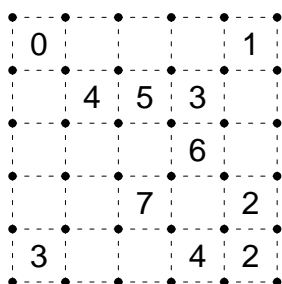

Y6 Statue Park

35 points

Place the given shapes into the grid, so that they do not share an edge (they may touch diagonally). The shapes can be rotated and reflected, and each shape must be used exactly once. Cells with black circles must be covered by one of the shapes, cells with white circles cannot be covered by any of the shapes. All cells that are not occupied by any shape, including those with white circles, must be connected.

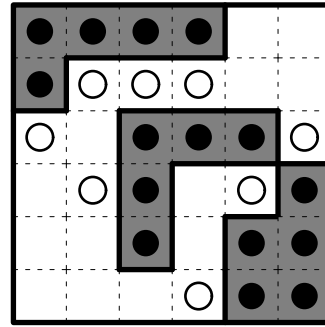
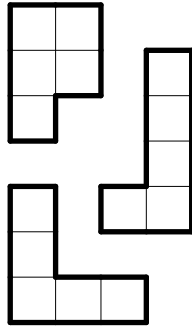
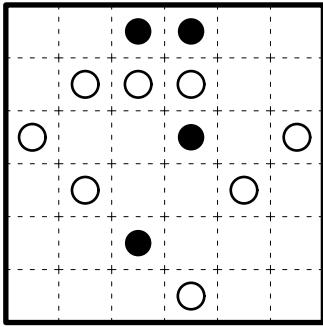

Y7 Terra X

40 points

Enter numbers from 0 to 9 into the grid, one into each region. Regions with equal numbers cannot share an edge (they may touch diagonally). For each grid point where four regions meet, the sum of the numbers in those regions must equal 10. For your convenience, all these grid points are marked with a small black dot.

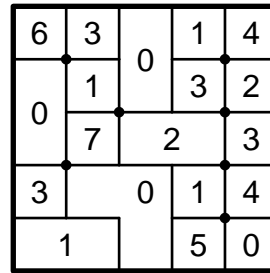
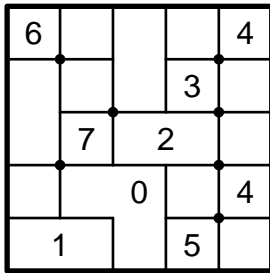

Y8 Congruence Loop

45 points

Draw a closed loop along the dotted lines that uses each grid point at most once. The loop must go through all grid points with numbers. For each number, consider the two loop parts starting in that grid point. The number indicates the maximum length for which these loop parts are congruent.

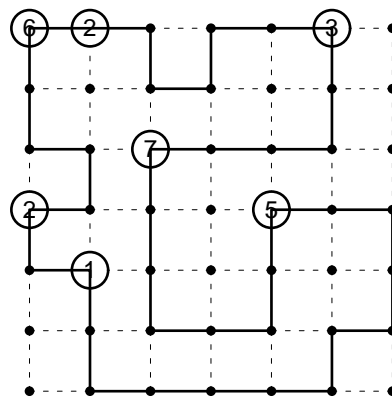
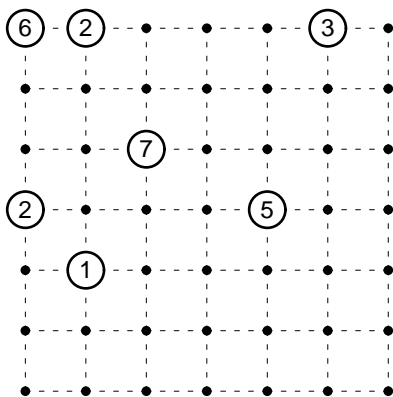

Y9 Chatroom

50 points

Draw lines from the @ symbols to the black and white circles, so that each @ is connected to one black and one white circle, and each circle is used exactly once. The lines run horizontally and vertically, and each empty cell is used by exactly one line. If a circle contains a number, that number indicates how often the line from the respective @ symbol to this circle makes a turn. In circles with a question mark the number of turns is unknown.

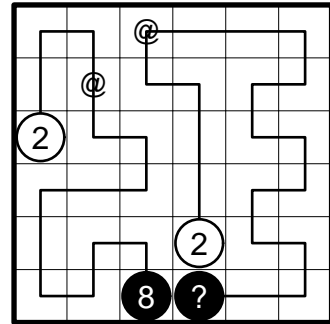
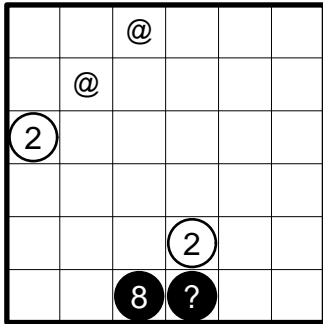

Y10 Total Castle Wall

50 points

Draw a closed loop into the grid that runs horizontally and vertically and passes through each cell at most once. Black cells must be outside the loop, white cells with heavy borders must be inside the loop; this includes marked cells with and without numbers. The numbers indicate the total length of all horizontal loop segments in the respective row plus the total length of all vertical loop segments in the respective column.

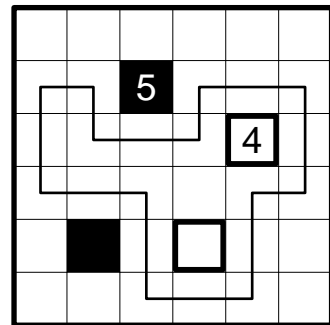
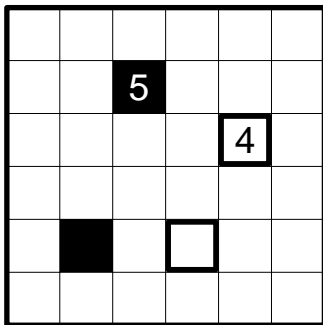

Y11 Underground

55 points

Draw the map of an underground railway into the grid. The map consists of horizontal and vertical lines connecting adjacent cells. All lines are interconnected, and there are no dead ends; some cells may remain unused. The numbers outside the grid indicate how many cells of a specific type (crossing, junction, straight line or curve, regardless of rotation) appear in the respective row or column.

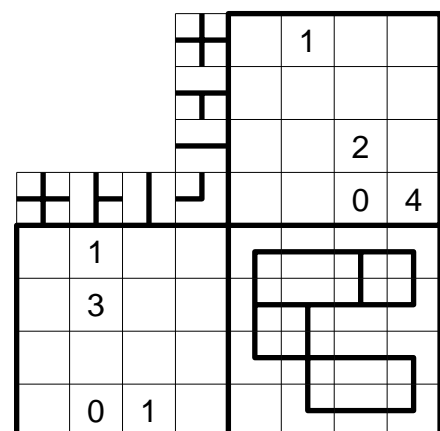
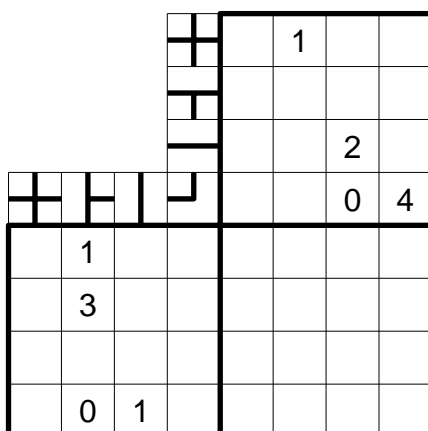

Y12 Pyramid 0-9

60 points

Enter a number from 0 to 9 into each empty cell, so that (with the exception of the bottom row) each number is either the sum or the difference of the two numbers directly below it. Within a shaded row, no number can appear more than once. In an unshaded row there must be at least one number appearing more than once.

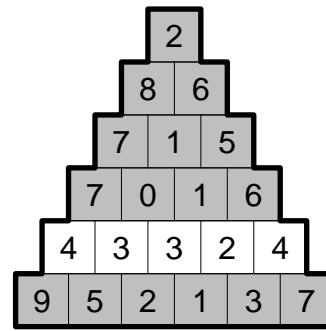
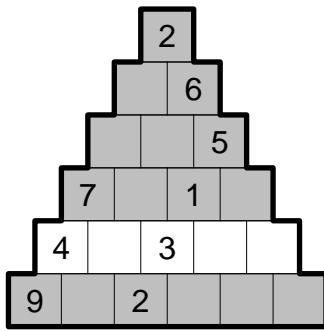

Y13 Deformable Masyu

70 points

Draw a closed loop into the grid that runs horizontally and vertically and passes through each cell at most once. The loop must go through all cells with circles. In a cell with a black circle, the loop must make a turn and pass straight through both cells before and after the circle. In a cell with a white circle, the loop must pass straight through and make a turn in a cell before or after the circle (or both). However, white circles can be shaded to transform them into black circles. To determine which circles to shade is part of the puzzle.

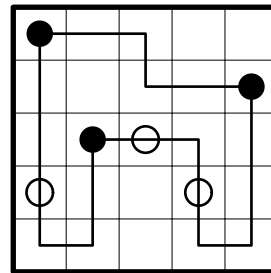
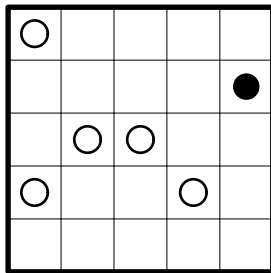

Y14 Summon

70 points

Enter digits from 1 to 3 into the grid, so that each digit appears exactly once in each region. Cells with equal digits cannot touch each other, not even diagonally. Digits in adjacent cells within a row or column form multi-digit numbers, read from left to right or from top to bottom; digits without neighbours form single-digit numbers. The numbers outside the grid indicate the sum of all such multi-digit and single-digit numbers in the respective row or column.

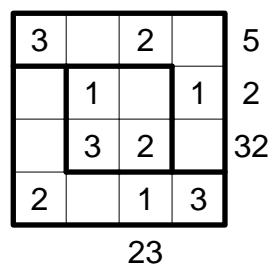
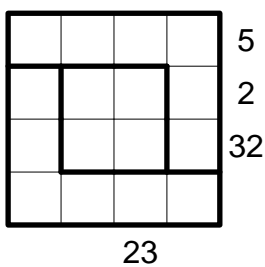

Round 11 Individual: Irregular

60 minutes – 700 points

11.1 Easy as ABC – Crosswise	20 points
11.2 Tapa Groups or Cells – Hexagonal	25 points
11.3 Lighthouses – Triangular	35 points
11.4 Sudoku – Fragment	35 points
11.5 Masyu – Pentagonal	45 points
11.6 Nanro Signpost – Pentagonal	60 points
11.7 Numbered Regions – Irregular	70 points
11.8 Walking Slitherlink – Hexagonal	90 points
11.9 Japanese Sums – Crosswise	100 points
11.10 Fillomino – 3D	110 points
11.11 Nurikabe – Hexagonal	110 points

In this round, all puzzles will have some kind of non-standard geometry.

11.1 Easy as ABC – Crosswise

20 points

Enter letters A, B, C into the grid, so that each letter appears exactly once in each “row”. Some rows make 90° turns in cells with rounded edges, so that all rows contain the same number of cells. The letters outside the grid indicate the first letter in the respective row, seen from the respective direction.

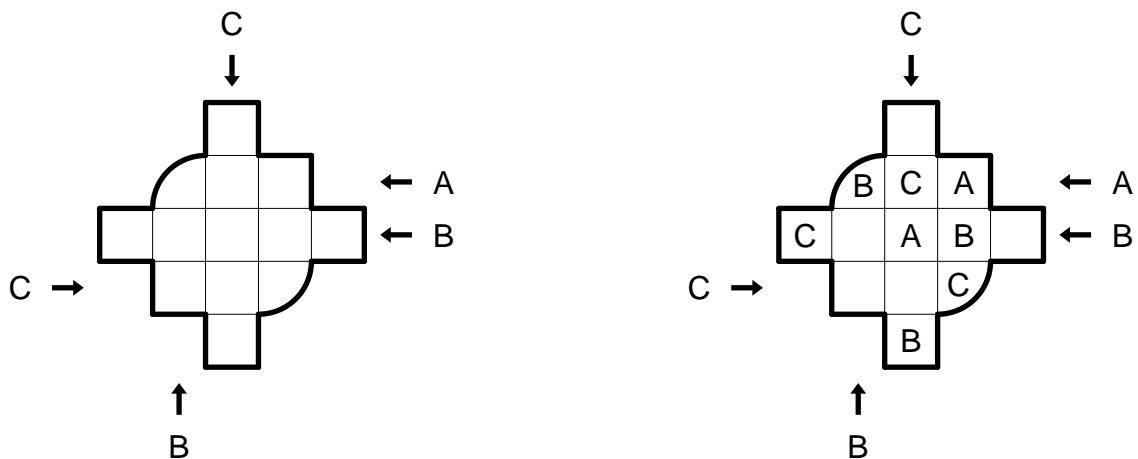

11.2 Tapa Groups or Cells – Hexagonal

25 points

Shade some cells so that all shaded cells are connected and no “triangle” (three cells adjacent to each other) is completely shaded. Cells with numbers cannot be shaded. Each number has one of two meanings:

- The number indicates how many of the adjacent cells are shaded, and these shaded cells form a contiguous group, or
- The number indicates how many separate groups of shaded cells are adjacent.

It is possible that clues conform to both meanings.



11.3 Lighthouses – Triangular

35 points

Place some ships into the grid. The ships have the size of a single cell and cannot touch each other or cells with numbers, not even in a single point. The numbers represent lighthouses and indicate how many ships can be seen in all six directions. Lighthouses can see through other ships. The number of ships is not known.

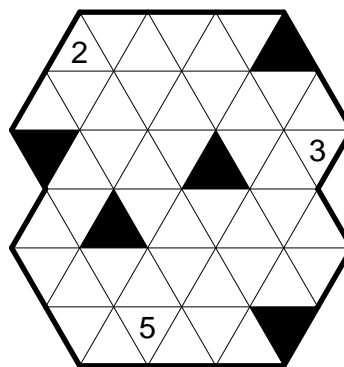
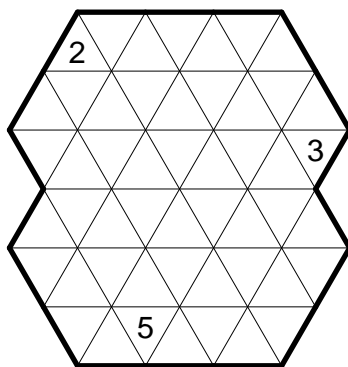

11.4 Sudoku – Fragment

35 points

Enter numbers from 1 to 8 into the grid, so that each number appears exactly once in each “row” and in each outlined region. A cell that is cut by a diagonal line must contain two numbers (one of which is already given). Shaded areas are not cells but holes, no numbers will be entered here. The “rows” run along the drawn lines and make multiple turns.

Note: The actual layout will be different, but similar in style.

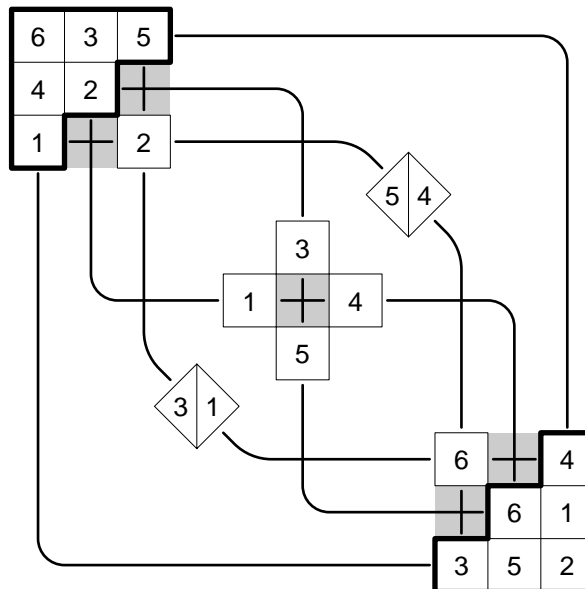
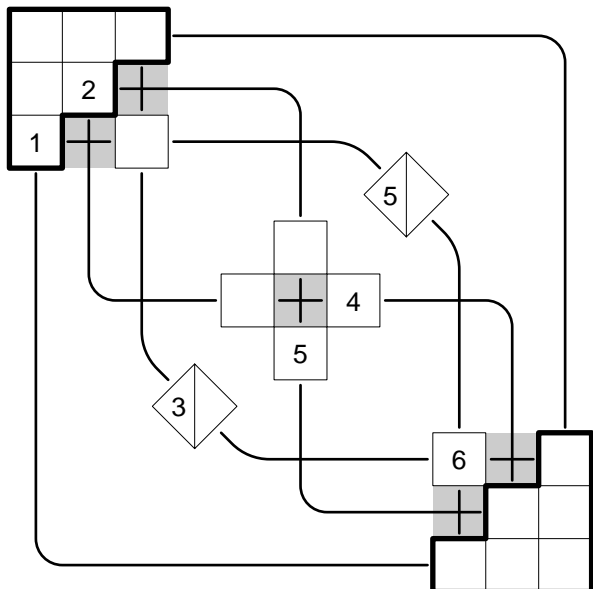

11.5 Masyu – Pentagonal

45 points

Draw a closed loop into the grid, that passes through each cell at most once. Consecutive cells along the loop must share an edge. The loop must go through all cells with circles. We say that the loop “makes a turn” in a cell if the edges that the loop crosses when entering and leaving that cell are adjacent (they share a point). In a cell with a black circle, the loop must make a turn, and in both cells before and after the black circle the loop cannot make a turn. In a cell with a white circle, the loop cannot make a turn, and it must make a turn in a cell before or after the white circle (or both).

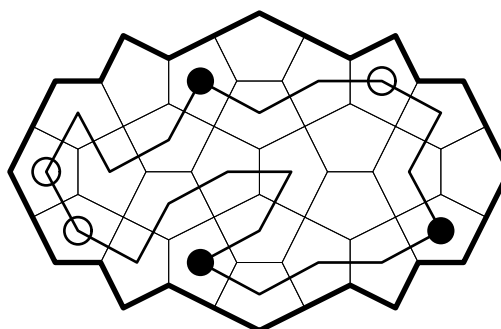
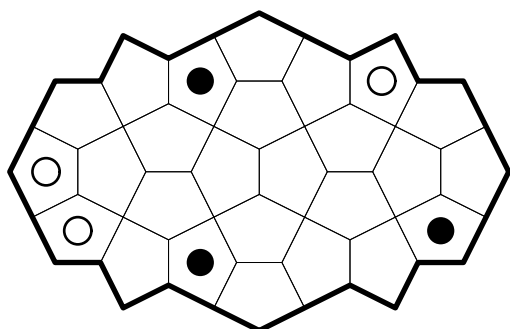

11.6 Nanro Signpost – Pentagonal

60 points

Enter numbers into some cells, so that all cells with numbers are connected via edges (two cells touching in a single point are not considered adjacent). No interior grid point is completely surrounded by numbers. Each region must contain at least one number. Within each region, all numbers must be the same and equal to the number of numbers within that region. Equal numbers in different regions cannot be placed in adjacent cells (again, touching in a single point is not adjacent and thus allowed). The clue numbers indicate which numbers must be entered in the respective region; the clue cell itself may or may not contain a number.

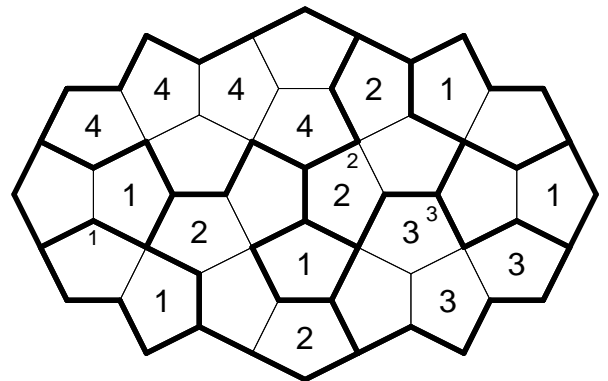
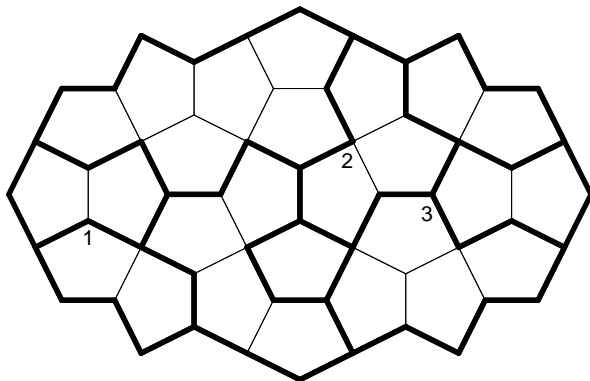

11.7 Numbered Regions – Irregular

70 points

Enter numbers from 1 to 16 into the grid, one into each region. The clue numbers indicate the sum of the entered numbers of the region itself and all adjacent regions. Regions are considered adjacent if they are sharing an edge.

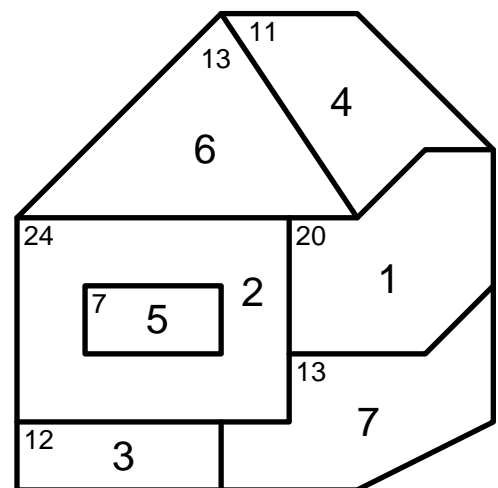
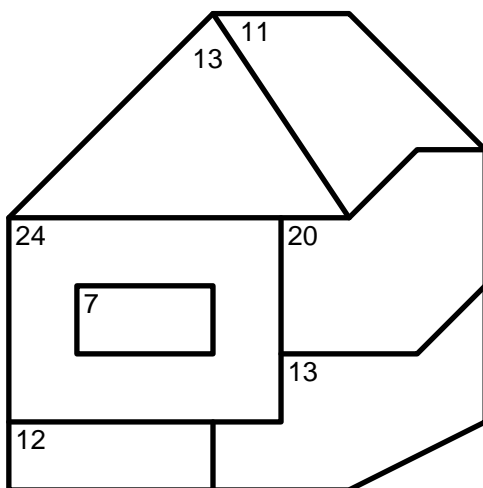

11.8 Walking Slitherlink – Hexagonal

90 points

Draw a closed loop along the dotted lines that uses each grid point at most once. A person walks along the loop, alternating between their left and right foot, always one edge per step. The numbers indicate how many steps on the edges of the respective cells that person makes with their right foot.

Note: It is sufficient to draw the loop, it is not necessary to mark the steps made with the right foot.

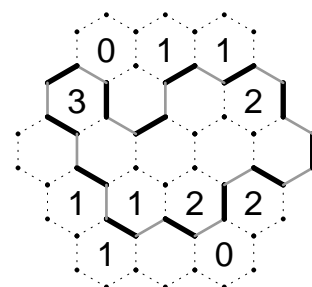
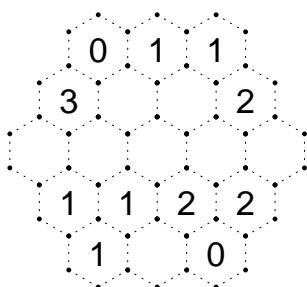

11.9 Japanese Sums – Crosswise

100 points

Enter numbers from 1 to 7 into the grid, so that each number appears at most once in each “row”, and shade the remaining cells. Some rows make 90° turns in cells with rounded edges, so that all rows contain the same number of cells. The numbers outside the grid describe the contents of the respective row. Each number corresponds to a contiguous group of numbers (possibly a single number) and indicates the sum of these numbers. Two such groups are separated by one or more shaded cells. For each row, the numbers outside are shown in correct order.

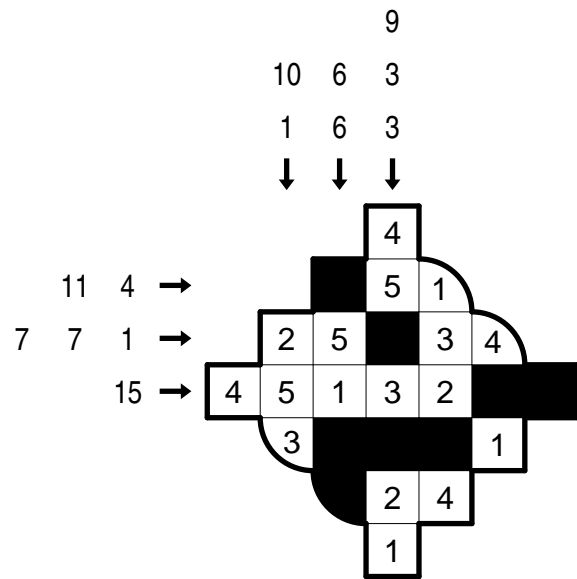
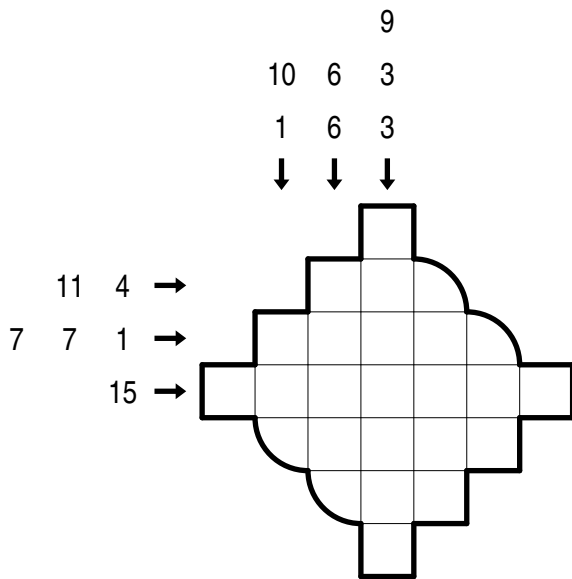

11.10 Fillomino – 3D

110 points

This puzzle is basically a Fillomino on a three-dimensional grid.

Enter a number into each empty circle. Two circles connected by a straight line are considered adjacent; crossings of these connecting lines are ignored. A “region” is a group of adjacent circles containing equal numbers. For each region, the number in all of its circles must be equal to the number of circles in this region. Two regions containing equal numbers cannot be adjacent. Regions may contain none, one or several of the given numbers.

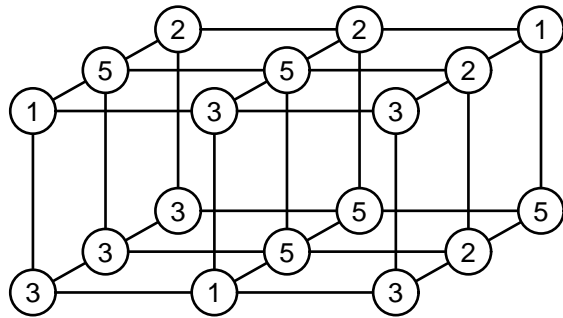
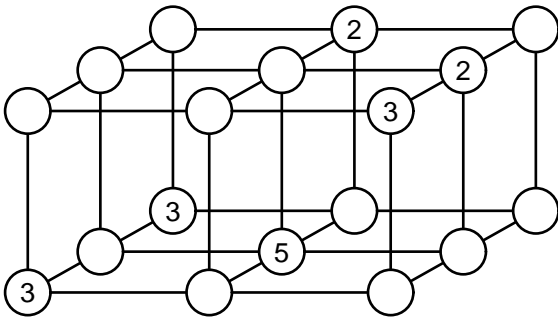

11.11 Nurikabe – Hexagonal

110 points

Shade some cells so that all shaded cells are connected and no “triangle” (three cells adjacent to each other) is completely shaded. Cells with numbers cannot be shaded. Each group of connected unshaded cells forms an island. Each island must contain exactly one number that is equal to the size of that island.

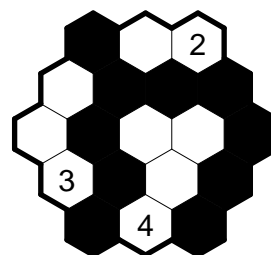
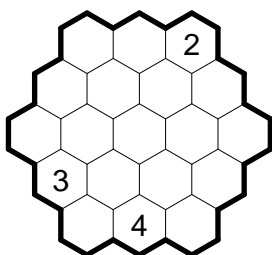

Round 12 Individual: Innovations

60 minutes – 700 points

12.1+12.2+12.3 Hideout Fences	10+30+50 points
12.4+12.5+12.6 No Same Sums	15+35+60 points
12.7+12.8+12.9 Pairing	15+20+25 points
12.10+12.11+12.12 Equality	20+30+55 points
12.13+12.14+12.15 Marbles	15+30+40 points
12.16+12.17+12.18 Diagonal Chains	15+30+50 points
12.19+12.20+12.21 Kirch + Heim	20+55+80 points

12.1+12.2+12.3 Hideout Fences

10+30+50 points

Draw a closed loop along the dotted lines that uses each grid point at most once. The numbers outside the grid indicate the sum of the numbers directly behind edges that are part of the loop in the respective row or column.

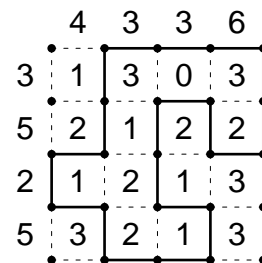
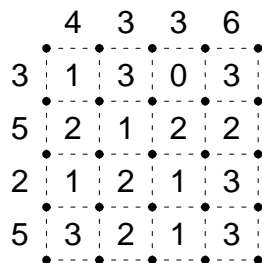

12.4+12.5+12.6 No Same Sums

15+35+60 points

Divide the grid into regions of any sizes and any shapes, so that no number appears more than once within a region. Regions that have at least one common number cannot touch each other, not even diagonally. When you add up all numbers in a region, the resulting sums must be different for all regions.

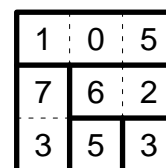
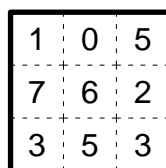

12.7+12.8+12.9 Pairing

15+20+25 points

Find a shape that can be created in two different ways by putting together two of the given pieces, so that in total each piece is used exactly once. All pieces can be rotated and reflected. An empty grid will be given to draw the shapes.

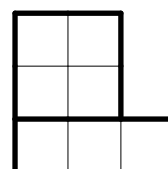
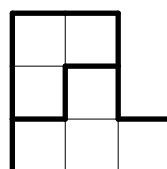
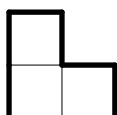
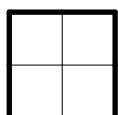
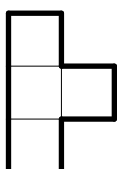

12.10+12.11+12.12 Equality

20+30+55 points

Draw a closed loop into the grid that runs horizontally and vertically and passes through each cell at most once. The loop must enter and leave each region at least twice. For multiple visits of the same region, each visit must pass through the same number of cells. That number can be equal or different for different regions. If a region contains a number, that number indicates how many cells in that region are not used by the loop. Grey cells cannot be used by the loop, and they are not part of any region.

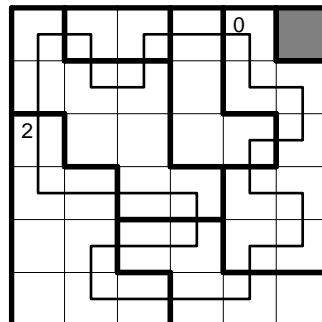
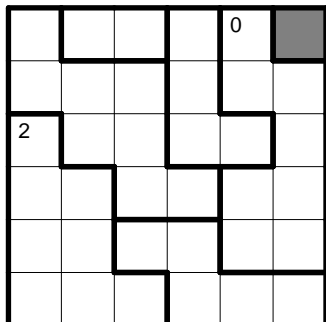

12.13+12.14+12.15 Marbles

15+30+40 points

Find the shading of marbles falling through a grid.

All marbles fall down vertically, one in each column. If a marble hits a diagonal wall, it rotates 90°, moves to the adjacent column and continues falling down vertically there. All marbles fall at the same time, however they do not interact with each other. The grid and the walls are given, no walls can be added or moved.

Each marble consists of four sectors. Each marble is either completely unshaded, or two adjacent sectors are shaded. The numbers outside the grid represent observers; they indicate the total number of shaded sectors of all falling marbles in the upper or lower half of the respective row. In rows with diagonal walls, shaded sectors are counted after the marbles have rotated.

Example 1:

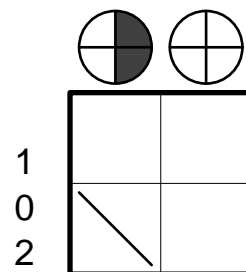
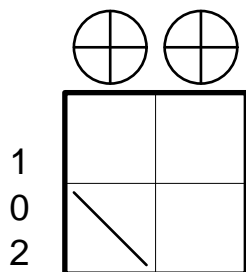

Example 2:

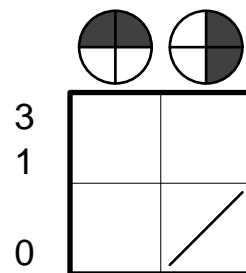
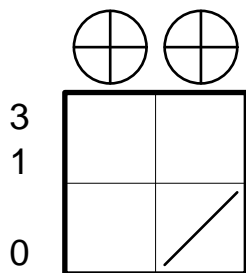

12.16+12.17+12.18 Diagonal Chains

15+30+50 points

Shade some cells to create diagonal chains. Shaded cells cannot be horizontally or vertically adjacent, and no shaded cell can touch more than two other shaded cells diagonally. Furthermore, there can be no “rings” – each group of diagonally connected cells must have at least one shaded cell with less than two diagonally touching shaded neighbours. Cells with numbers cannot be shaded.

The numbers indicate the sum of the lengths of all such chains where at least one shaded cell is horizontally, vertically or diagonally neighbouring to the numbered cell.

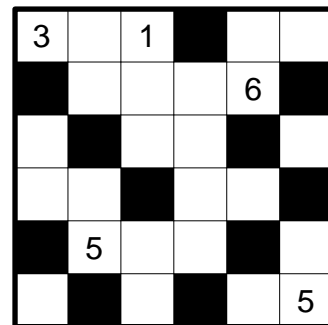
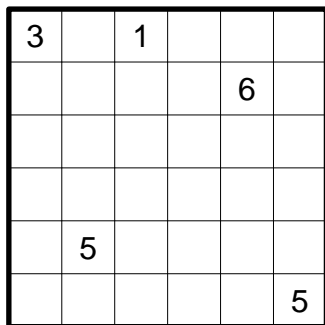

12.19+12.20+12.21 Kirch + Heim

20+55+80 points

Place churches and residential buildings into the grid. Each building consists of a triangular roof and one or two squares, see below. The buildings cannot be rotated. Identical shapes that belong to different buildings cannot touch each other, not even diagonally. The numbers outside the grid indicate how many shapes of a specific type appear in the respective row or column. The number of buildings of each type is unknown, possibly zero.

Note: The name of this puzzle type is a play on the name of the town “Kirchheim”, which can be split into “Kirch” (church) and “Heim” (home).

A list of buildings:

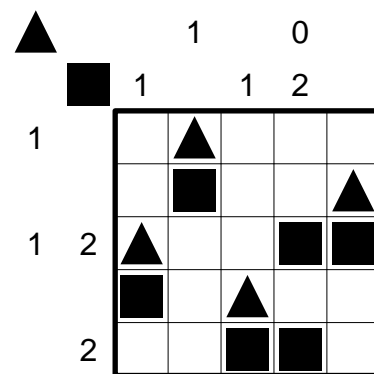
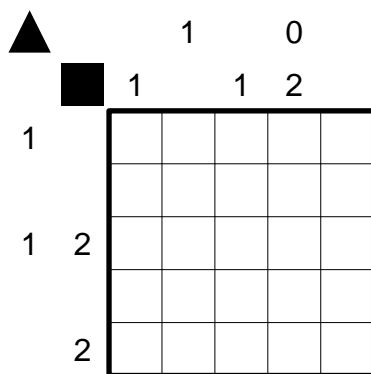

Round 13 Team: Loopfinder

75 minutes – 3000 points

Loopfinder 3000 points
 (partial solution: 40 points per correctly assigned rule)
 (partial solution: 90 points per solved grid)

This round consists of eight separate puzzle grids that are part of one large puzzle. Each grid has different rules. The task is to determine which rules belong to which grid, and solve the resulting puzzles.

The following general rules are valid for all eight puzzle grids:

Draw a closed loop into the grid that runs horizontally and vertically. The loop must pass through all cells with circles and numbers. The loop may cross itself (unless this is prohibited by a special rule for an individual grid), but not in cells with circles; aside from that, no cell can be visited more than once. No crossings or unused cells are given.

There are additional rules in seven categories. Each grid must conform to exactly one rule from each category, and each rule must apply to exactly two grids. To find out which rules are assigned to each grid is part of the puzzle.

Note: In some categories it is possible that single clues might conform to several rules of that category. This is allowed. However, for each grid there can be only one rule that fits all clues of the same kind.

The rules are represented by the following icons:

Category 1: General – Global Rules

This category contains rules about global properties, namely restrictions on crossings and unused cells.

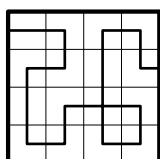

The loop must pass through all cells.

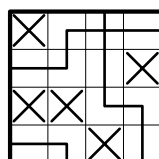

Each row and column must contain at least one cell that is not used by the loop.

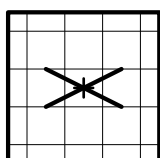

The loop cannot cross itself.

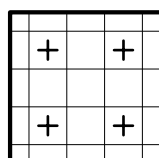

The loop must cross itself at least once, but cells with crossings cannot touch each other, not even diagonally.

Category 2: Numbers Left – Segments

This category deals with clue numbers on the left side of the grid. These clues refer to horizontal loop segments in the respective row. A line connecting two adjacent cells is defined as length 1.

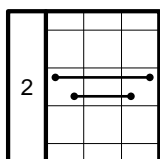

Each clue number indicates how many separate horizontal loop segments appear in the respective row.

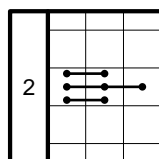

Each clue number indicates the length of the longest loop segment in the respective row.

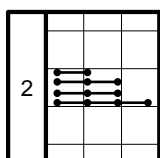

Each clue number indicates the length that appears most often in the respective row. No other length can appear the same number of times.

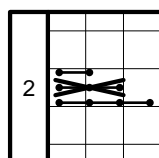

Each clue number indicates a length that is not found in the respective row.

Category 3: Numbers Above – Crossings

This category deals with clue numbers above the grid. There are exactly three such clue numbers in each grid. These clues indicate the number of crossings in the respective column. However, not all of these numbers are correct.

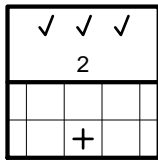

All three clue numbers are correct.

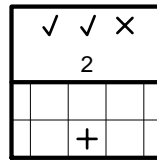

Exactly two clue numbers are correct.

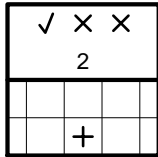

Exactly one clue number is correct.

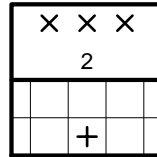

None of the clue numbers is correct.

Category 4: Numbers Inside – Geradeweg

This category deals with clue numbers inside the grid. These numbers are Geradeweg clues: a number indicates the length of the loop segment passing through its cell. If the loop makes a turn or crosses itself in a cell with a number, both segments must have the respective length. However, some clues are Knapp Daneben, which means that each clue number is either 1 higher or 1 lower than the actual length of the loop segments. If the loop makes a turn or crosses itself in a Knapp Daneben clue number, the horizontal and vertical loop segments may have the same or different length.

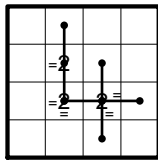

All clue numbers indicate the correct length (no Knapp Daneben). The loop may pass straight through, turn or cross itself in a clue cell.

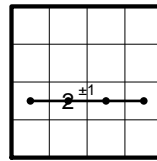

All clue numbers are Knapp Daneben, and the loop must pass straight through all clue cells without crossing itself there.

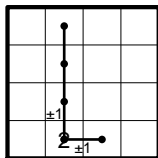

All clue numbers are Knapp Daneben, and the loop must make a turn in all clue cells.

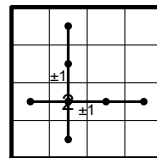

All clue numbers are Knapp Daneben, and the loop must cross itself in all clue cells.

Category 5: Circles – Masyu

This category deals with circles inside the grid. Some circles have Masyu properties. In all grids all circles look the same, the colours are just descriptions of the Masyu rules: A white Masyu circle means that the loop passes straight through the circle and makes a turn in at least one of the cells immediately before or after the circle. A black Masyu circle means that the loop makes a turn in the circle and passes straight through (with or without crossing itself) the cells immediately before and after the circle. Some circles have neither property, they are not valid Masyu circles of either colour.

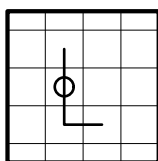

All circles are white Masyu circles.

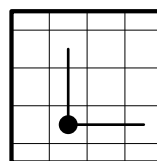

All circles are black Masyu circles.

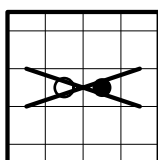

All circles are neither white nor black Masyu circles.

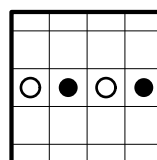

All circles are white or black Masyu circles, and along the loop white and black circles alternate (the loop never passes through two circles of the same colour consecutively).

Category 6: Arrows – Myopia

This category deals with diagonal arrows inside the grid. These clues are Myopia-like arrows. From each grid point with one or more arrows, these arrows point to the nearest cells in the four diagonal directions that have a certain property. If there is no arrow in a specific direction, then the nearest cell with the specified property is farther away, or there may be no such cell in the given direction at all.

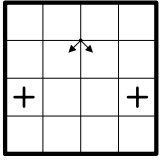

The arrows point to the nearest cells in the four diagonal directions where the loop crosses itself.

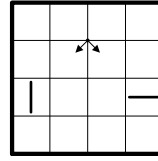

The arrows point to the nearest cells in the four diagonal directions where the loop passes straight through.

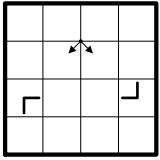

The arrows point to the nearest cells in the four diagonal directions where the loop makes a turn.

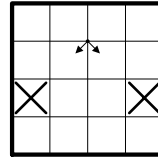

The arrows point to the nearest cells in the four diagonal directions that are not used by the loop.

Category 7: Grey Regions – Symmetry

This category deals with grey regions. All such regions are 2×2 squares. Each such region must have an axis of symmetry. Aside of this, there are no restrictions on the loop; grey regions may contain crossings and unused cells, even completely empty regions are allowed. Symmetry refers only to the loop, not to additional elements (circles, arrows, numbers).

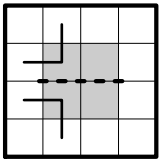

In all regions, the axis of symmetry must run horizontally.

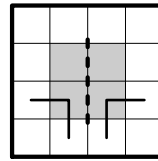

In all regions, the axis of symmetry must run vertically.

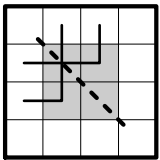

In all regions, the axis of symmetry must run diagonally, from top left to bottom right.

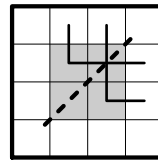

In all regions, the axis of symmetry must run diagonally, from bottom left to top right.

During the competition, each team will receive a table exactly as the one on the next page. The puzzle grids are labeled with letters from A to H. When you have identified a specific rule in a puzzle grid, enter the respective letter below the icon representing this rule. In a completely solved puzzle, there will be two letters below each icon.

Scoring: Teams receive points for correctly identified rules. Every correct letter is worth 40 points, and every correctly solved puzzle is worth 90 points. However, if there are more than two letters below an icon, these letters will yield 0 points, even if one or two of them are correct. Similarly, if a letter appears below two icons in the same category, this letter will yield 0 points in this category, even if it is entered below the correct icon.

All puzzle grids may have multiple solutions with different rule combinations. However, there is only one solution for all puzzle grids simultaneously, and only solutions and rules that are part of this full solution will yield any points.

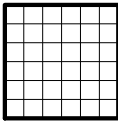
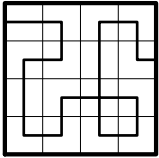
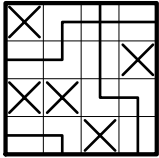
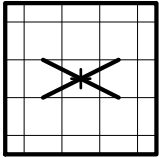
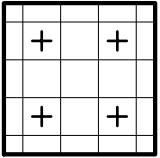
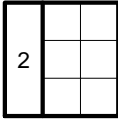
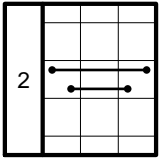
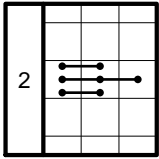
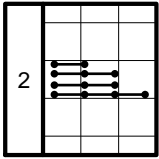
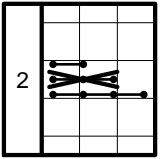
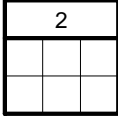
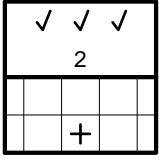
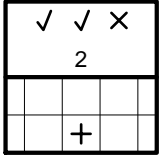
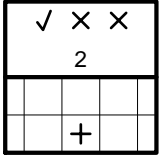
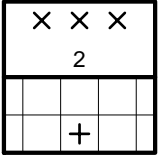
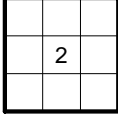
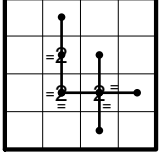
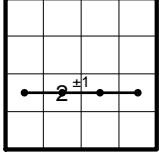
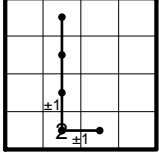
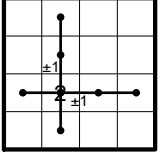
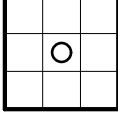
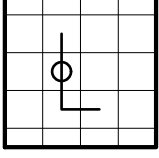
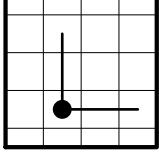
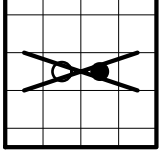
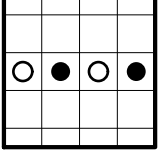
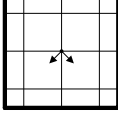
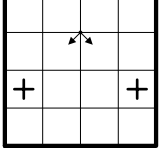
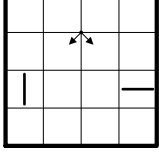
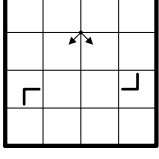
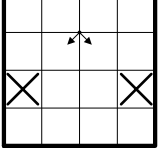
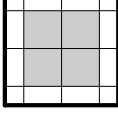
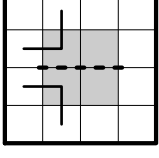
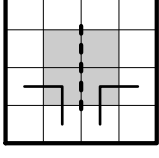
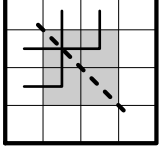
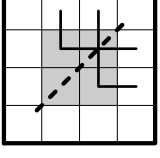
 <p>General: Global Rules</p>				
 <p>Numbers Left: Segments</p>				
 <p>Numbers Above: Crossings</p>				
 <p>Numbers Inside: Geradeweg</p>				
 <p>Circles: Masyu</p>				
 <p>Arrows: Myopia</p>				
 <p>Grey Regions: Symmetry</p>				

Example (with four puzzle grids only; each rule must be used in exactly one grid):

A

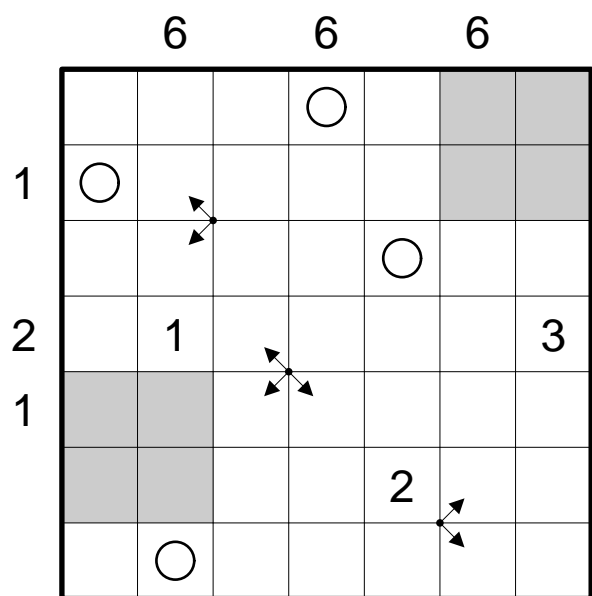

B

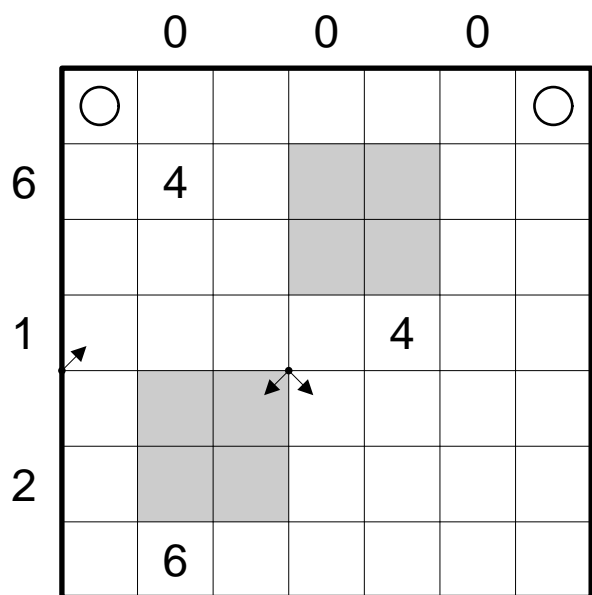
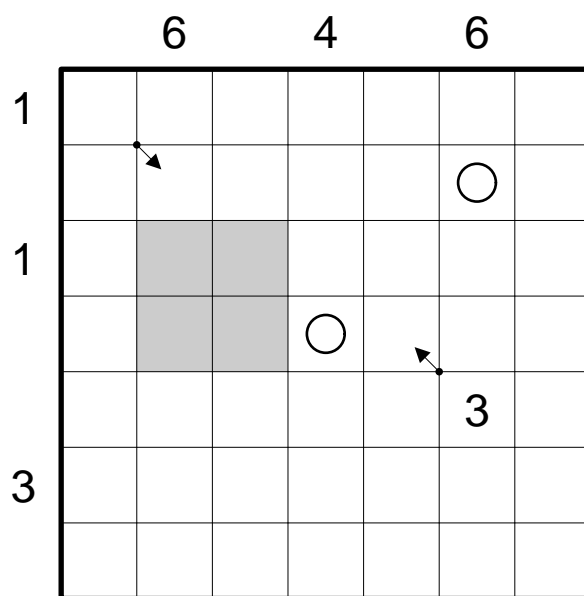

C

D

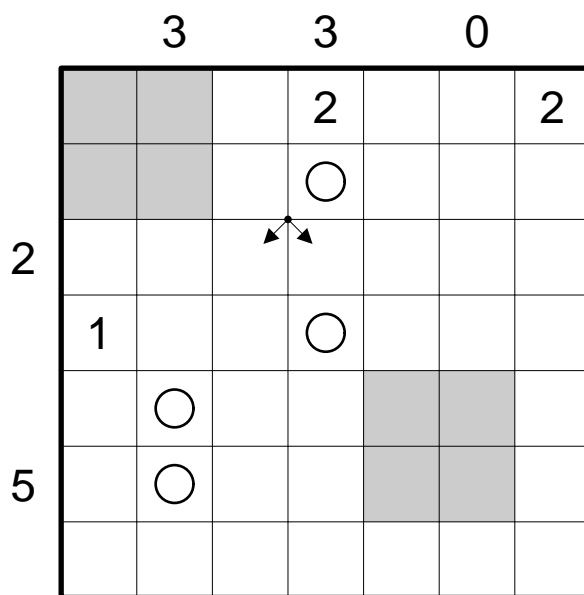

The next pages contain the solutions of the example, both the completed table and the solved puzzles.

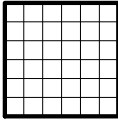
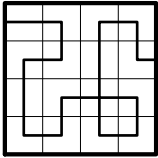
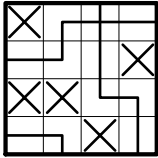
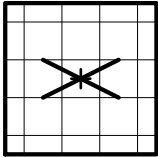
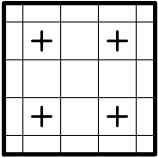
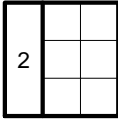
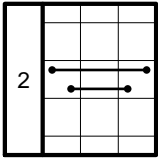
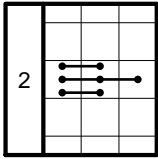
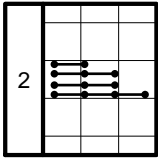
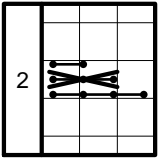
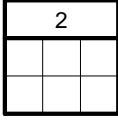
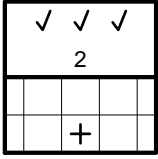
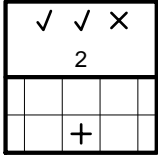
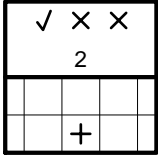
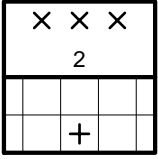
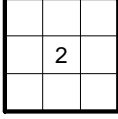
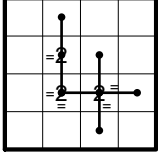
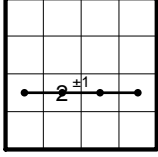
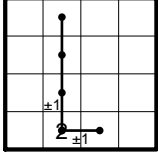
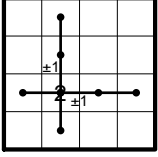
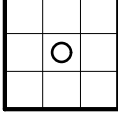
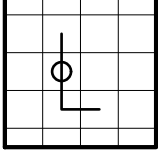
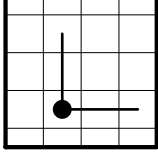
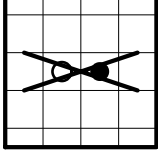
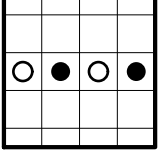
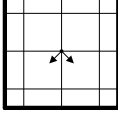
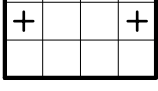
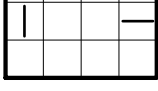
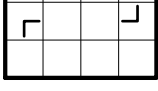
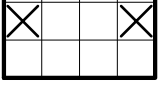
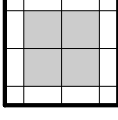
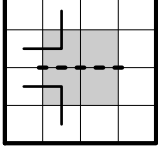
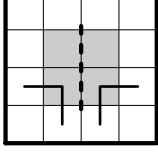
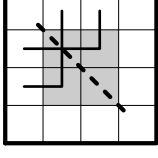
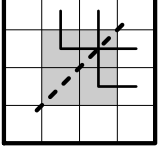
 General: Global Rules	 B	 D	 A	 C
 Numbers Left: Segments	 A	 D	 B	 C
 Numbers Above: Crossings	 C	 D	 B	 A
 Numbers Inside: Geradeweg	 C	 A	 D	 B
 Circles: Masyu	 A	 C	 B	 D
 Arrows: Myopia	 D	 B	 A	 C
 Grey Regions: Symmetry	 A	 B	 D	 C

Solution of the example puzzles:

A

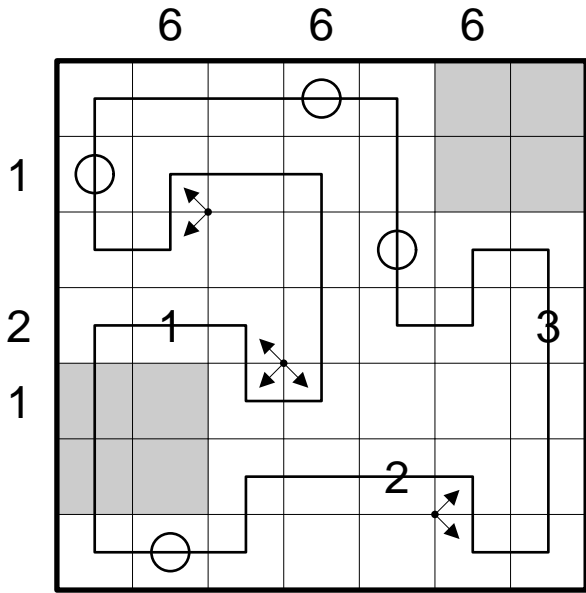

B

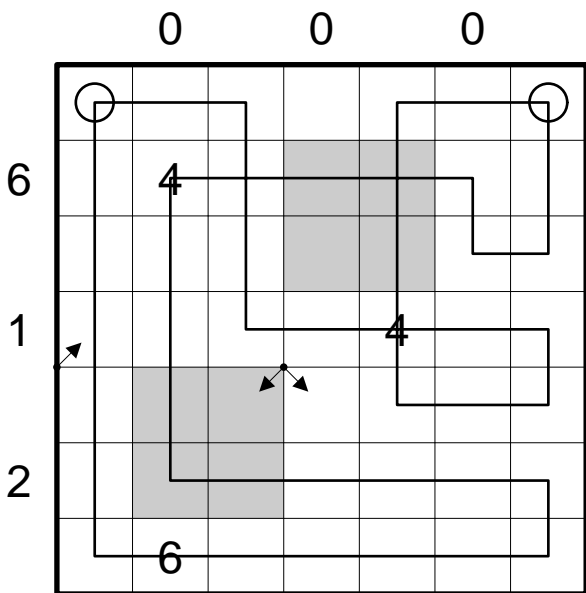
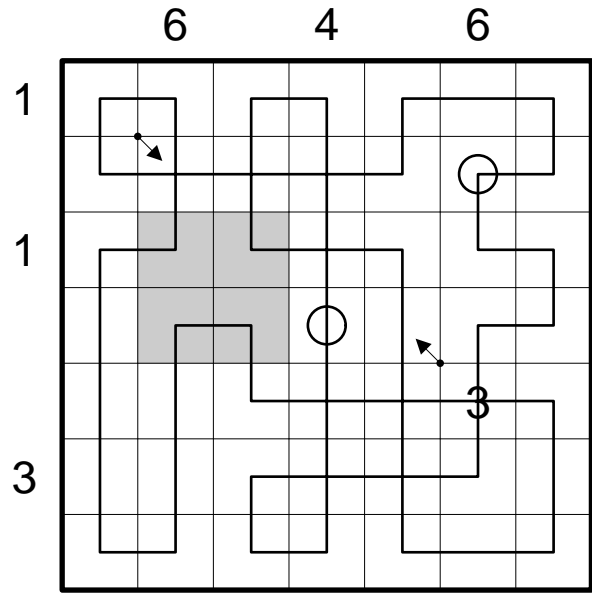

C

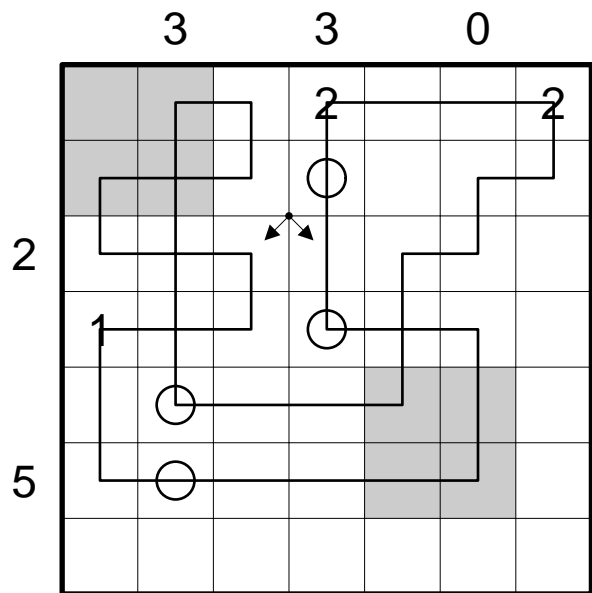

D

Round 14 Individual: Jigsaw Kropki

35 minutes – 300 points

14.1 Jigsaw Kropki 6×6 50 points

14.2 Jigsaw Kropki 7×7 90 points

14.3 Jigsaw Kropki 8×8 160 points

This round consists of three separate puzzles. For each puzzle, the task is:

Assemble an $N \times N$ square from the given pieces to create a solvable Kropki puzzle, and solve it. Some pieces have white and black semicircles at their borders; the pieces must be matched so that these semicircles form full monochrome circles. No single semicircle can remain either within the puzzle or at its outer border, and a circle consisting of a white half and a black half is not permitted either. The pieces can be rotated but not reflected.

The rules of a standard $N \times N$ Kropki are: Enter numbers from 1 to N into the grid, so that each number appears exactly once in each row and column. A white circle between two adjacent cells indicates that the numbers in these cells have a difference of 1. A black circle indicates that one of the numbers is twice the other. If there is no circle between two horizontally or vertically adjacent cells, then the numbers in these cells cannot fulfil either condition. A circle between 1 and 2 can be either white or black.

Competitors will receive a puzzle booklet with three empty grids and an envelope with pieces for all three puzzles. Which pieces belong to which puzzle will be noted next to the grids; there will be no ambiguity. At the beginning of the round, please make sure you have received all pieces. The puzzle booklet will contain neither instructions nor example, so if you need them, make sure to bring this instruction booklet with you.

Note: Some of the pieces may have a (more or less) heavy black border. These are just remnants from the cutting template, they are not relevant for the actual puzzles. Specifically, these borders do not define regions of any kind; aside from the Kropki rules there is no restriction whether numbers can appear multiple times or not at all on any of the pieces. Furthermore it is not possible to draw conclusions from the black borders to the placement of the pieces, the cutting template was not a solved puzzle.

While the competitors are allowed to solve the puzzles either on paper or on the pieces, the solutions must be copied into the empty grids in the puzzle booklet. A solution on the pieces only will not be accepted. For a correct solution it is sufficient to enter the numbers into the grid, it is not necessary to draw the circles or the dissection into the pieces. All four rotations of the correct solutions will be accepted.

Example (5×5):

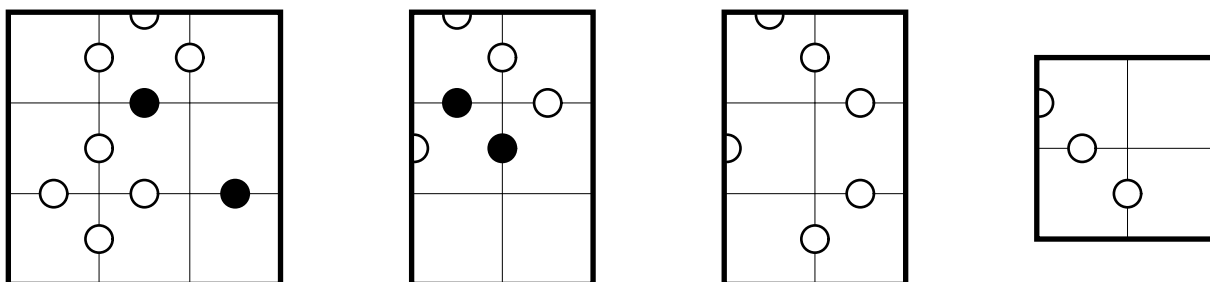

The assembled 5×5 square:

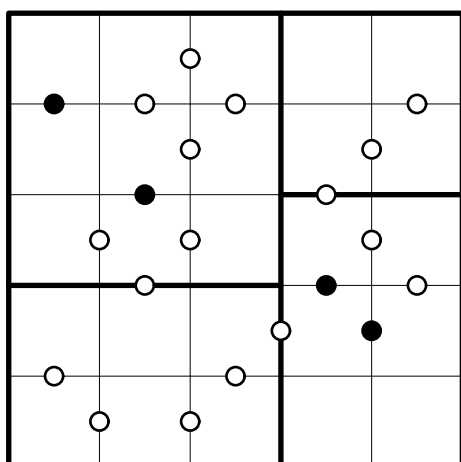

The complete solution:

2	5	○	4	1	3
●	○	○	○	○	○
1	4	○	5	3	○
○	●	○	○	○	○
3	○	2	○	4	○
○	○	○	○	○	○
5	1	3	○	2	●
○	○	○	○	○	○
4	○	3	○	2	5
○	○	○	○	○	○
4	3	○	2	5	1

Puzzle World Cup: Round 3

45 minutes – 600 points

Z1 Akari	15 points
Z2 Yin & Yang	15 points
Z3 Japanese Sums	20 points
Z4 New Tren	25 points
Z5 Star Battle	25 points
Z6 Yajilin	25 points
Z7 Dominion	30 points
Z8 Araf	30 points
Z9 Sternenhimmel	30 points
Z10 Blackout Dominoes	35 points
Z11 Hashi	35 points
Z12 BACAA	40 points
Z13 Persistence of Memory	40 points
Z14 Partiti	45 points
Z15 Magic Labyrinth	60 points
Z16 Kakuro	60 points
Z17 Magnets	70 points

Z1 Akari

15 points

Place light bulbs in some cells, so that they illuminate all unshaded cells. Each bulb illuminates all cells horizontally and vertically in all four directions up to a shaded cell or the border of the grid. Light bulbs cannot be placed in shaded cells or in cells with numbers, and they cannot light at each other. The numbers indicate how many lightbulbs are placed in horizontally and vertically adjacent cells.

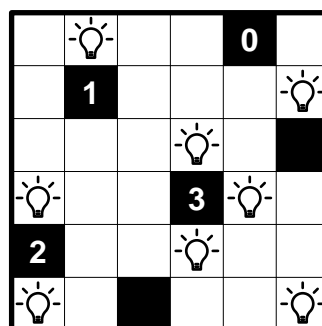
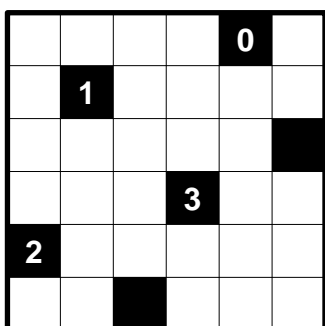

Z2 Yin & Yang

15 points

Enter a white or black circle into each empty cell, so that all white circles are connected, likewise all black circles. No 2x2 square can contain four circles of the same colour.

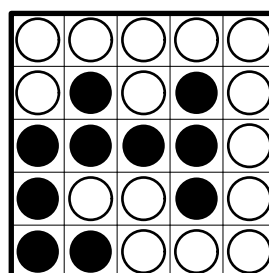
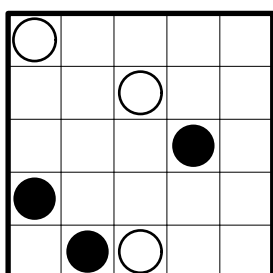

Z3 Japanese Sums

20 points

Enter numbers from 1 to 6 into the grid, so that each number appears at most once in each row and column, and shade the remaining cells. The numbers outside the grid describe the contents of the respective row or column. Each number corresponds to a contiguous group of numbers (possibly a single number) and indicates the sum of these numbers. Two such groups are separated by one or more shaded cells. For each row and column the numbers outside are shown in correct order.

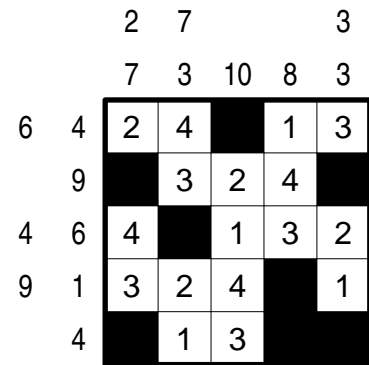
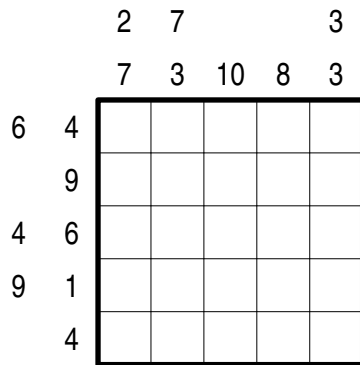

Z4 New Tren

25 points

Place some blocks of sizes 1×2 and 1×3 into the grid, so that they do not overlap. Each block must contain exactly one number that indicates the total number of possible movements of this block towards the directions of their shorter edges, up to another block or the border of the grid. All cells that are not part of any block must be connected.

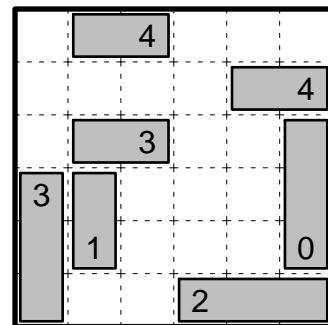
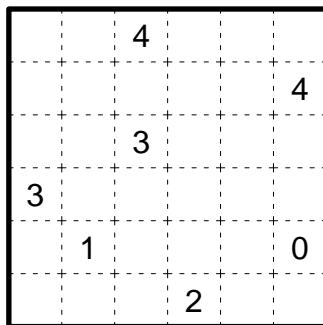

Z5 Star Battle

25 points

Place stars into the grid, so that there are exactly two stars in each row, column and outlined region. The stars do not touch each other, not even diagonally.

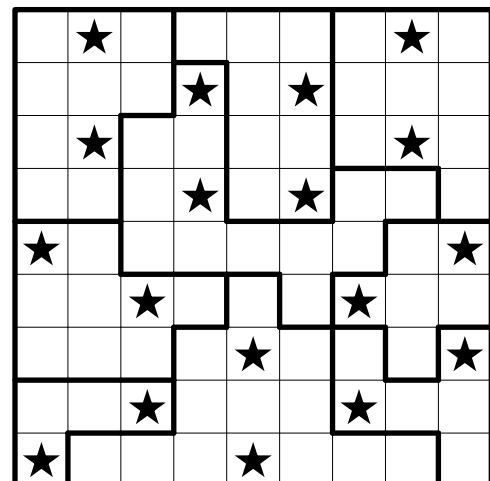
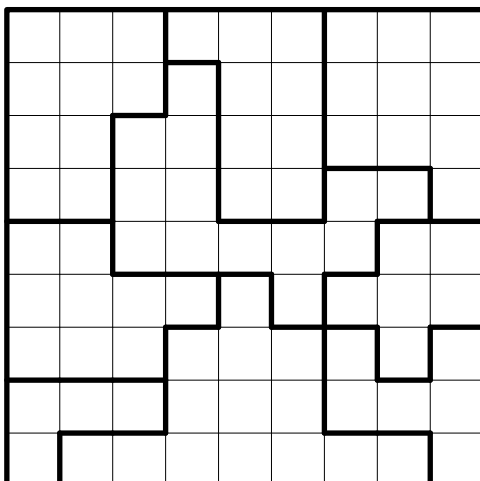

Z6 Yajilin

25 points

Shade some cells and draw a closed loop that runs horizontally and vertically and passes through each cell except the shaded cells and the clue cells exactly once. Clue cells cannot be shaded, and shaded cells cannot be horizontally or vertically adjacent (they can touch each other diagonally). The numbers indicate how many shaded cells appear in the specified direction.

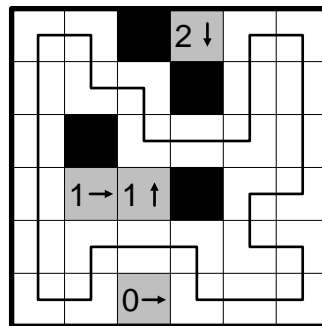
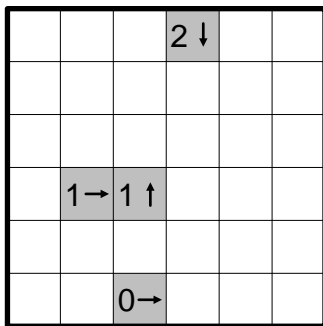

Z7 Dominion

30 points

Shade some cells, so that each shaded cell is horizontally or vertically adjacent to exactly one other shaded cell; in other words, the shaded cells form dominoes that do not share a border. Cells with letters cannot be shaded. The dominoes may touch each other diagonally, and by doing so they divide the grid into separate regions. Each region must contain at least one letter. Same letters must be located in the same region and different letters in different regions.

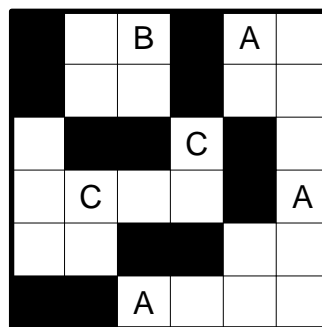
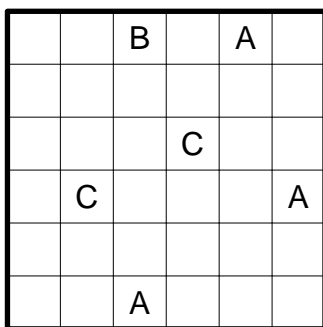

Z8 Araf

30 points

Divide the grid into regions so that each region contains exactly two numbers. For each region, one of its numbers is greater than its size and the other is smaller.

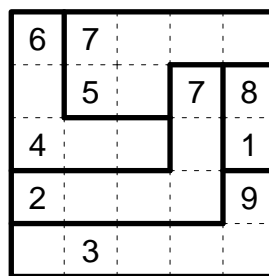
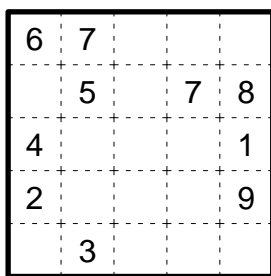

Z9 Sternenhimmel

30 points

Place some stars into the grid, so that each arrow points to at least one star and for each star there is at least one arrow pointing at it. Stars cannot be placed in cells with arrows. The numbers indicate how many stars appear in the respective row or column.

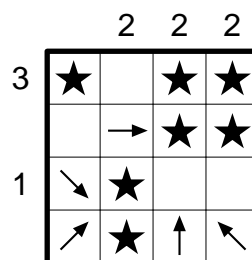
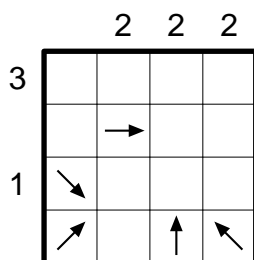

Z10 Blackout Dominoes

35 points

Shade some cells, divide the remaining unshaded cells into dominoes and enter numbers into the unshaded cells, so that each domino appears exactly once. Horizontally or vertically adjacent cells that are part of different dominoes must contain equal numbers. Shaded cells cannot be horizontally or vertically adjacent to each other or to the border of the grid, they may touch each other or the border diagonally.

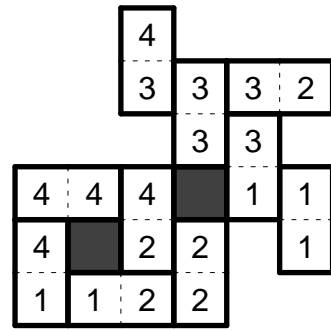
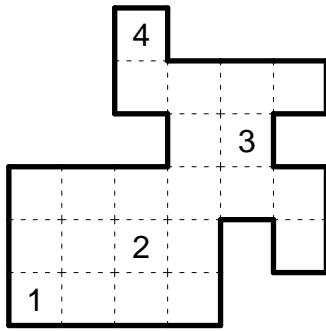

Z11 Hashi

35 points

Connect the islands represented by circles via bridges, so that all islands are interconnected. Bridges can be placed horizontally or vertically, and they cannot cross each other. Two islands can be directly connected by at most two bridges. The numbers indicate how many bridges start in the respective islands.

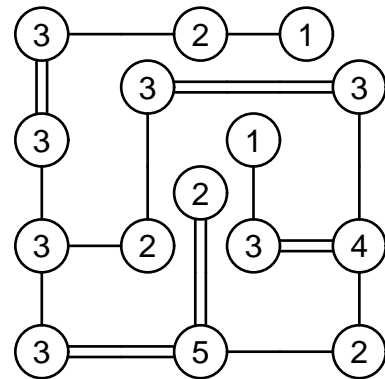
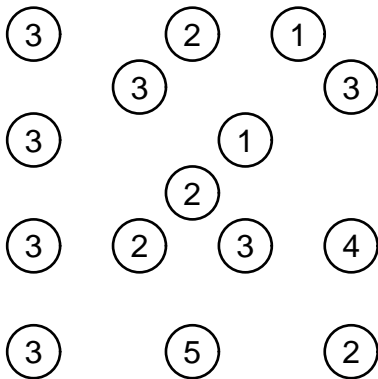

Z12 BACAA

40 points

Shade some cells and enter letters A, B, C into the grid, so that each row and column contains the letters A, A, B, C (attention – twice the letter A) and all other cells are shaded. Cells with given letters can either be shaded or keep the given letter, however no other letter can be entered in such cells. The letters outside the grid indicate the first letter in the respective row or column, seen from the respective direction. The numbers outside the grid describe the shaded cells in the respective row or column: Each number corresponds to a contiguous group of shaded cells, the number indicates the length of that group. Two such groups are separated by one or more letters. The numbers appear in the correct order.

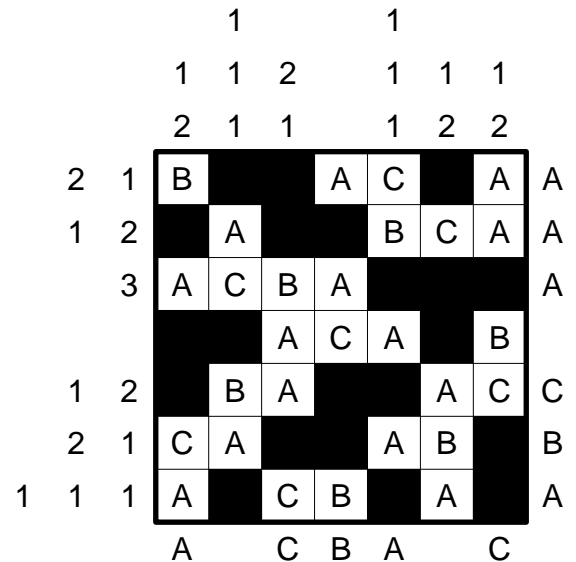
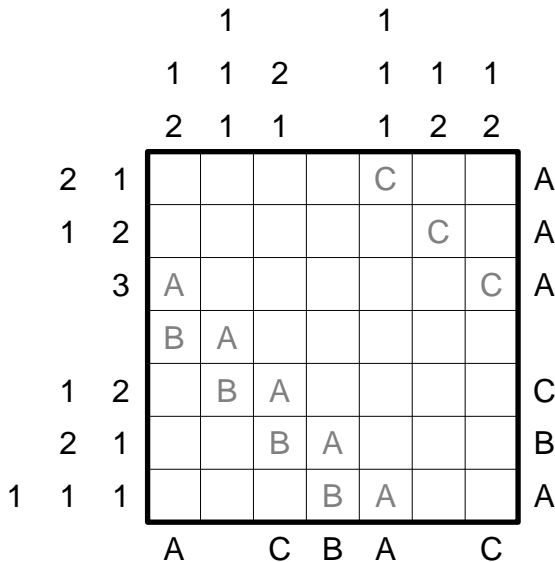

Z13 Persistence of Memory

40 points

Draw a path into the grid that starts in one circle, runs horizontally and vertically and ends in the other circle. The path uses each cell at most once, and it doesn't touch itself, not even diagonally. The path must use at least one cell from each outlined and shaded region. If two or more regions have the same shape and orientation, then the path must go through these regions exactly in the same way, including the points where it enters and leaves these regions.

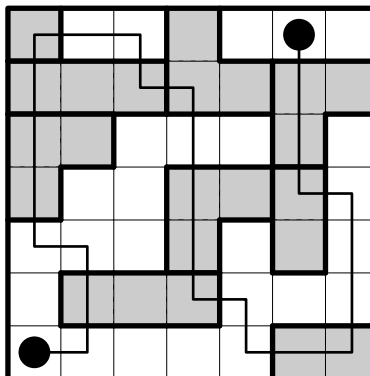
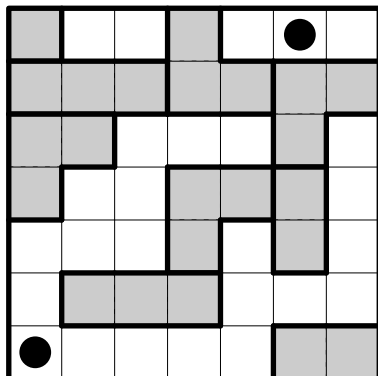

Z14 Partiti

45 points

Enter one or more numbers from 1 to 9 into each cell. Within a cell, no number appears more than once. Cells that have at least one common number cannot touch each other, not even diagonally. The clue numbers indicate the sum of all entered numbers in the respective cells.

19	4	2	7	7
3	11	8		4
	7	3	3	21
7	14	9	7	2
6	6	5	7	1

19	4	2	7	7
379	4	2	16	25
3	11	8		4
12	56	8	7	4
9	34	12	3	21
7	14	9	7	2
7	68	9	7	2
6	6	5	7	1
15	24	5	34	1

Z15 Magic Labyrinth

60 points

Enter numbers from 1 to 4 into the grid, so that each number appears exactly once in each row and column. Following the path from the outside, the sequence 1, 2, 3, 4 must always repeat, starting with a 1. Cells marked with a – cannot contain any numbers.

			–
3			

1	3	2	–
	2	3	1
2	1		3
3		1	2

Z16 Kakuro

60 points

Enter a number from 1 to 9 into each white cell. The numbers in grey cells indicate the sums of the numbers in the horizontally or vertically adjacent “words”. Within each word, no number can appear more than once.

	4	23		28	9
10			17		
3			9		
	7		12		
	10				14
34					
12			8		

	4	23		28	9
10	3	7	17	9	8
3	1	2	9	8	1
	7		12		
	10		1	4	2
34	7	4	8	6	9
12	3	9	8	3	5

Z17 Magnets

70 points

Fill the grid with neutral (shaded) and magnetic plates. Each magnetic plate has two poles, represented by + and – signs. Poles of the same type cannot be horizontally or vertically adjacent. The numbers indicate how many poles of the corresponding type appear in the respective row or column.

+			1
–	2		0
2	1		
	1		
2			

+			1
–	2		0
2	1	– +	+
	1		–
2		+ – +	

Team Playoffs – Individual part

The team playoffs start with an individual part. There are four sets of two puzzles: Standard, Combination, Knapp Daneben, Coded. Teams can decide freely which team members solve which sets. However, once the playoffs started, switching is not allowed. The eight puzzle types are:

Standard: ABC Box

Enter a letter A, B or C into each cell. The clues outside the grid describe the contents of the respective row or column. Each character (letter, number or question mark) corresponds to a contiguous group of cells containing the same letter:

- A letter outside the grid indicates the contents of all cells of the corresponding group.
- A number indicates the length of the corresponding group.
- A question mark gives no further information besides the existence of such a group.

For each row and column, the clues are given in correct order.

		?	C	2	?	
		?	?	C	1	
		?	1	?	B	
?	B	?				
1	?	?				
	?	2				
A	?	?				

		?	C	2	?	
		?	?	C	1	
		?	1	?	B	
?	B	?	C	C	B	A
1	?	?	C	B	B	A
	?	2	B	B	C	C
A	?	?	A	C	B	B

Standard: Castle Wall

Draw a closed loop into the grid that runs horizontally and vertically and passes through each cell at most once. Black cells must be outside the loop, white cells with heavy borders must be inside the loop; this includes marked cells with and without numbers. The numbers indicate the total length of all loop segments in the specified direction.

	1→				
		1↑			3↑
					2←

	1→				
		1↑			3↑
					2←

Combination: Doppelblock + Skyscraper Sums

Enter numbers from 1 to 5 into the grid and shade the remaining cells, so that each row and column contains each number exactly once as well as two shaded cells. The numbers represent skyscrapers of the respective height.

The numbers outside the grid are both Doppelblock and Skyscraper Sums clues:

- Each clue number indicates the sum of the numbers between the two shaded cells in the respective row or column.
- Each clue number indicates the sum of the heights of all visible skyscrapers in the respective row or column, ignoring the shaded cells.

Each clue must be valid in both respects.

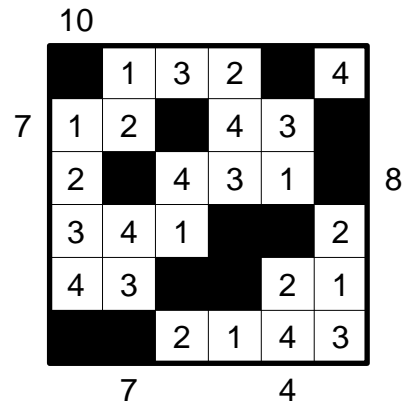
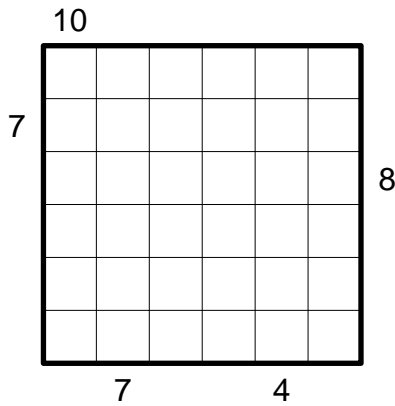

Combination: Coral + Star Battle

Shade some cells so that all shaded cells are connected, all unshaded cells are connected to the border of the grid and no 2x2 square is completely shaded.

Further, place stars into some unshaded cells, so that there are exactly two stars in each row and column. The stars do not touch each other, not even diagonally.

The clues outside the grid describe the contents of the respective row or column. For each row or column, one of the numbers indicates the number of cells between the two stars; each other number corresponds to a contiguous group of shaded cells, the number indicates the length of that group. Some numbers have been replaced by question marks. For each row and column, the clue numbers are sorted in increasing order, with the question marks always at the beginning, regardless of which numbers they replace. For some rows or columns the clues have been omitted entirely.

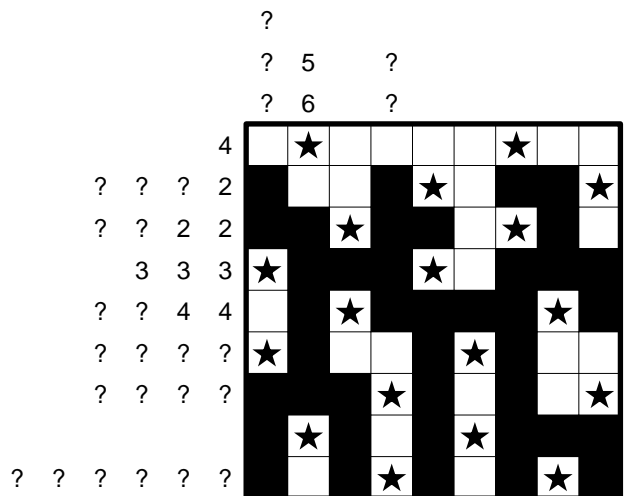
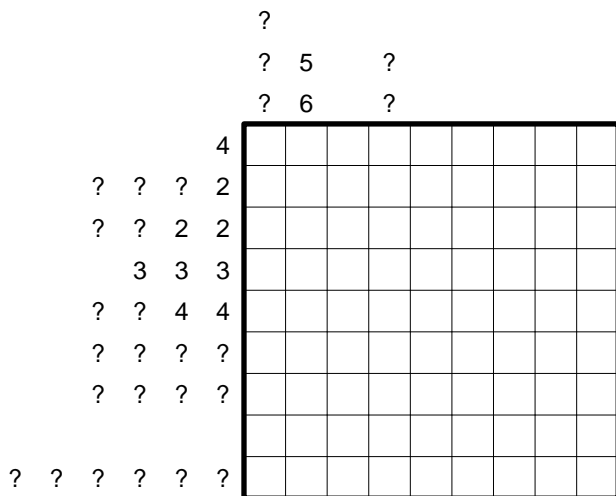

Knapp Daneben: Hashi

Connect the islands represented by circles via bridges, so that all islands are interconnected. Bridges can be placed horizontally or vertically, and they cannot cross each other. Two islands can be directly connected by at most two bridges. The numbers indicate how many bridges start in the respective islands.

However, all numbers are “Knapp Daneben”, which means that each clue number is either 1 higher or 1 lower than the actual number of bridges.

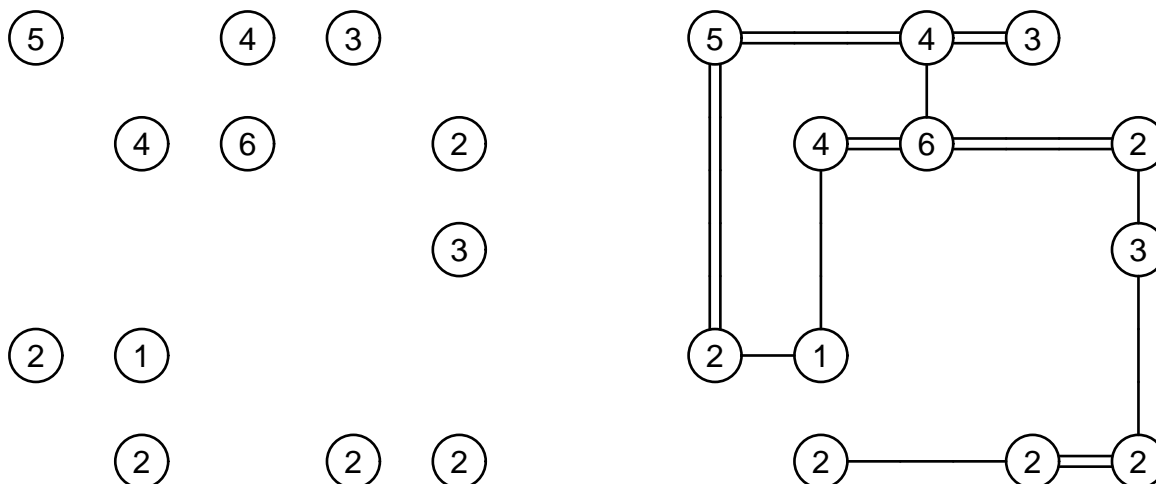

Knapp Daneben: Lookouts

Divide the grid into regions of given sizes. Each number indicates the total number of cells within its region that can be seen horizontally or vertically from that cell, including the numbered cell itself. All numbers that are maximal within their region are given, and no other numbers are given.

However, all numbers inside the grid are “Knapp Daneben”, which means that each clue number is either 1 higher or 1 lower than the actual number of visible cells. Regions can contain both higher and lower clue numbers. The region sizes remain unchanged.

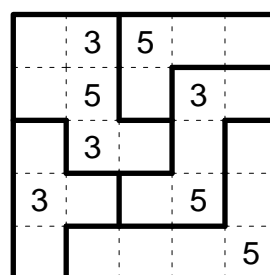
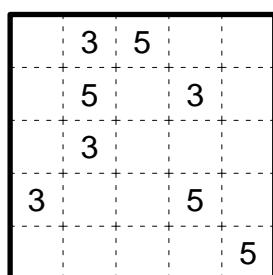

Region sizes:

4, 4, 5, 6, 6

Coded: Tetrominoes

Place the given tetrominoes into the grid so that they do not touch each other, not even diagonally. Tetrominoes can be rotated but not reflected. The numbers above and to the left of the grid indicate how many tetromino cells appear in the respective row or column; the numbers below and to the right of the grid indicate how many tetrominoes appear in the respective row or column.

All numbers have been replaced by letters. Same letters represent same numbers, different letters represent different numbers. A number 0 is allowed. There are no multi-digit numbers.

	A	B	C	D	B	B	
D							C
A							D
D							C
C							C
E							D
D							D
	D	D	C	C	D	D	

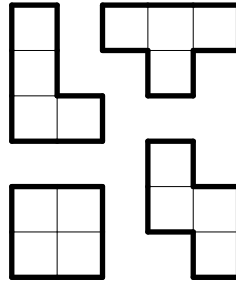

	A	B	C	D	B	B	
D							C
A							D
D							C
C							C
E							D
D							D
	D	D	C	C	D	D	

A	B	C	D	E

A	B	C	D	E
4	3	1	2	5

Coded: Japanese Sums

Enter numbers from 1 to 7 into the grid, so that each number appears at most once in each row and column, and shade the remaining cells. The numbers outside the grid describe the contents of the respective row or column. Each number corresponds to a contiguous group of numbers (possibly a single number) and indicates the sum of these numbers. Two such groups are separated by one or more shaded cells. For each row and column the numbers outside are shown in correct order.

In the clue numbers, the digits from 0 to 9 have been replaced by ten letters. Same letters represent same digits, different letters represent different digits. A single-digit clue number cannot be 0, and two-digit numbers cannot start with a 0.

			A						
	A	BC	D	F	G	J			
	BC	BC	E	BB	H	BG			
H	BE								
	BC								
E	J	BB							
	K	A							
BB	J	B							
	EB								

			A						
	A	BC	D	F	G	J			
	BC	BC	E	BB	H	BG			
H	BE		6		5	3	4		
	BC	1	4	3	2				
E	J	BB	2		4		5	6	
	K	A		2	1	6		3	
BB	J	B	6	5		4		1	
	EB		4	3	2	1	6	5	

A	B	C	D	E	F	G	H	J	K

A	B	C	D	E	F	G	H	J	K
3	1	0	8	2	7	5	6	4	9

Team Playoffs – Team part

The team area of each team consists of four tables. On each team table, there are four puzzles of the same type, forming a “group”, arranged in a fixed way on a very large sheet. The four puzzle types are: Pentopia, Pento Words, Slitherlink, Fillomino. Within each group, the puzzles are linked. Solutions of team puzzles are only considered valid if the link condition (see below) is satisfied. A group can only be handed in as a whole.

At the beginning, all team puzzles are covered. Each puzzle cover has a letter (A, B, C or D), so that each group contains one puzzle for each letter. A participant who advances to the team area receives a letter; they are allowed to uncover the puzzles with this letter, but no others, and start solving. The Pento Words group also has a word list, which is uncovered from the start. Also, each team has a collection of pentominoes, which is not covered either.

The given pentomino collection contains twice the full set, so there are 24 separate pentominoes in total. Pentominoes may be rotated and reflected (that is, turned over) at will. Within each group, the full collection must be used – no more, and no less. That is, each pentomino shape must be used exactly twice in a group. Each grid must use exactly six different pentominoes.

Each pair of same pentominoes is tied together by a thin thread. This “link” has a maximal length (and the material does not stretch, so it is not possible to extend the maximal length). The material is quite sturdy and will not break from normal use. It is possible of course to use enough force to damage the links. Please don’t.

A group solution is only valid if the positions of the pentominoes are such that, for each pair, the distance is no longer than the allowed maximal length. Specifically, it must be possible to lay down both pentominoes at the same time at the respective positions. The links are hooked into the pentominoes at both ends. You may be able to gain a few millimeters by turning the hooks into a favorable direction; in close situations this might be necessary.

The links for different shapes may have different lengths. However, the lengths of the links are the same for all teams. The arrangement of the grids will vary between different groups, but all teams have also the same grid arrangements.

Different notations are allowed (as long as the solution is clear). It is not enough, though, to just place the given pentomino pieces on the grid; the solution must be actually drawn. For Pentopia and Pento Words, the solution consists only of the positions of all the pentominoes. For Slitherlink and Fillomino, the pentomino positions are only part of the solution; the full solution must be drawn.

In the following examples, each puzzle uses four different pentominoes. These puzzles are completely independent from each other. During the WPC, an example group including a set of pentominoes will be shown.

Pentopia

Place exactly six different pentominoes into each grid, so that they do not touch each other, not even diagonally. Pentominoes can be rotated and reflected. Pentominoes cannot overlap cells with arrows. If a cell contains one or more arrows, the arrows indicate the directions of the nearest pentomino cells. If there is no arrow in a specific direction, then the nearest pentomino cell is farther away, or there may be no such cell in this direction at all.

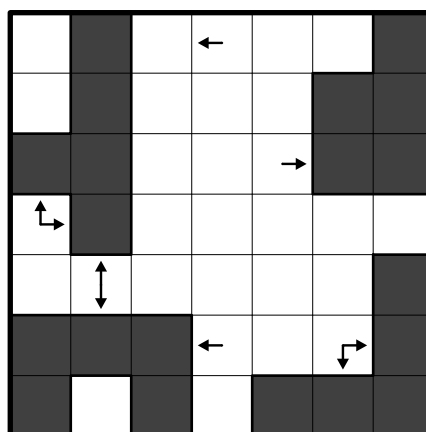
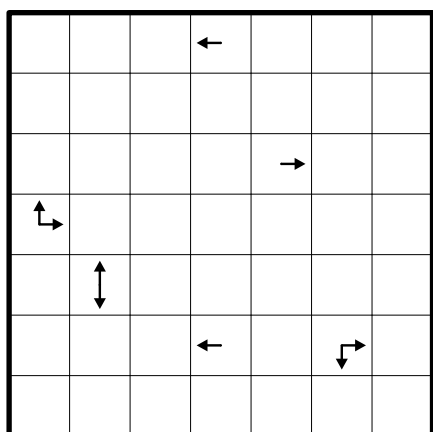

Pento Words

A list of 24 five letter words is given. Place exactly six different pentominoes into each grid, so that they do not touch each other, not even diagonally. Pentominoes can be rotated and reflected. Each pentomino must cover the letters of one of the given words (in any order), and each word must be used exactly once.

R	E	D	P	L	R
E	I	G	A	E	P
G	O	T	G	U	D
L	S	C	A	Y	I
H	L	H	T	S	E
O	T	A	R	W	H

GREED
PRIDE
SLOTH
WRATH

R	E	D	P	L	R
E	I	G	A	E	P
G	O	T	G	U	D
L	S	C	A	Y	I
H	L	H	T	S	E
O	T	A	R	W	H

Slitherlink

Draw a closed loop along the dotted lines that uses each grid point at most once. The numbers indicate how many edges of the respective cells are part of the loop.

The interior of each loop must consist of exactly 30 cells and it must be divided into six different pentominoes so that the link condition is satisfied.

Note: For a correct solution it is sufficient to draw the loops, it is not necessary to draw the placement of the pentominoes.

		1			
0	3		2	3	
			2		
1		3		1	2
1		2			2
	2			3	

		1			
0	3		2	3	
			2		
1		3		1	2
1		2			2
	2			3	

Fillomino

Divide the grid into several regions, so that regions of the same size do not share an edge (they may touch diagonally). Each number indicates the size of the region it is located in. Regions may contain none, one or several numbers.

In each grid, the number 5 is given exactly six times. The resulting regions of size 5 are the pentominoes that must satisfy the link condition. Each pentomino must contain exactly one of the given 5s, and no other regions of size 5 can appear. Within each grid, no pentomino can be used more than once.

		2		5	
5					4
		4		4	
		2	3	2	
4				2	5
3	5				

5	5	5	1	5	1	5
5	4	2	2	5	5	5
5	4	4	3	4	4	4
4	1	4	3	2	4	5
4	4	2	3	2	5	5
4	3	2	5	5	2	5
3	3	5	5	5	2	5

Further notes:

At the team area, any communication within a team is allowed.

Clearly, we were not able to check the distance for every single available position on all the grids. We believe that, for all the relevant positions during solving, it is clearly apparent whether the link is long enough or not. If you are in doubt about a specific position anyway, you may ask an arbiter who will be in the competition room throughout the playoff round.

The team has only one collection of pentominoes, which must be used for all groups. Please do not pull on the pentomino links too hard. If a link breaks (but only then), the team can get a spare copy. If a copy breaks – well, you are out of luck.

